

MN3204

512-STAGE LOW VOLTAGE OPERATION LOW NOISE BBD

General description

The MN3204 is a 512-stage low voltage operation ($V_{DD} = 5V$) low noise BBD that provides a signal delay of up to 25.6ms and is suitable for use as reverberation effect of low voltage operation audio equipments such as portable stereo and radio cassette recorders.

Features

- Variable signal delay of the audio signal: 1.26ms ~ 25.6ms.
- Wide range of source voltage: 4 ~ 10V.
- No insertion loss: $L_i = 0dB$ typ.
- Wide dynamic range: $S/N = 77dB$ typ.
- Low distortion: $THD = 0.4\%$ typ. ($V_i = 0.25V_{rms}$).
- Clock frequency range: 10KHz ~ 200KHz.
- N channel silicon gate process.
- 8-Lead Dual-In-Line Plastic Package.

Applications

- Reverberation and echo effects of audio equipments such as radio cassette recorder, portable radio, portable stereo, echo microphone and pre-taped musical accompaniment (Karaoke), etc.
- Sound effect of electronic musical instruments.
- Variable or fixed delay of analog signals.

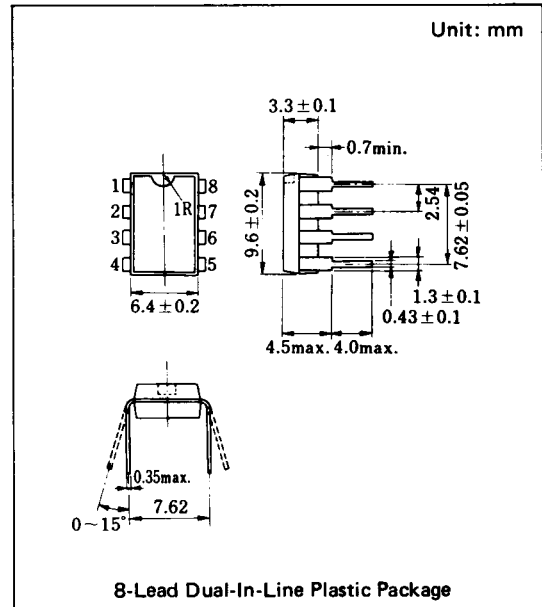

Block Diagram

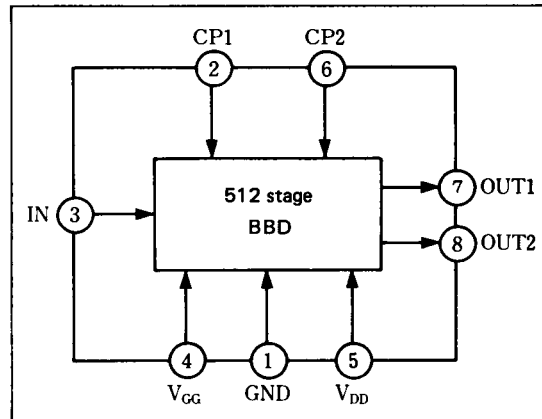

Quick Reference Data

Item	Symbol	Value	Unit
Supply Voltage	V_{DD}, V_{GG}	+ 5, $\frac{1}{3} V_{DD}$	V
Signal Delay Time	t_D	1.28 ~ 25.6	ms
Total Harmonic Distortion	THD	0.4	%
Signal to Noise Ratio	S/N	77	dB

■ Absolute Maximum Ratings (Ta = 25°C)

Item	Symbol	Rating	Unit
Terminal Voltage	V _{DD} , V _{GG} , V _{CP} , V _I	-0.3~+11	V
Output Voltage	V _O	-0.3~+11	V
Operating Ambient Temperature	T _{opr}	-20~+60	°C
Storage Temperature	T _{stg}	-55~+125	°C

■ Operating Condition (Ta = 25°C)

Item	Symbol	Condition	Min.	Typ.	Max.	Unit
Drain Supply Voltage	V _{DD}		+4	+5	+10	V
Gate Supply Voltage	V _{GG}			14/15 V _{DD}		V
Clock Voltage "H" Level	V _{CPH}			V _{DD}		V
Clock Voltage "L" Level	V _{CPL}		0		+1	V
Clock Frequency	f _{CP}		10		200	kHz
Clock Pulse Width *1	t _{CPW}				0.5T *2	
Clock Rise Time *1	t _{CPr}				500	ns
Clock Fall Time *1	t _{CPf}				500	ns
Clock Input Capacitance	C _{CP}				350	pF
Clock Cross Point *1	V _X		0		0.3V _{CPH}	V

■ Electrical Characteristics (Ta = 25°C, V_{DD} = V_{CPH} = 5V, V_{CPL} = 0V, V_{GG} = 14/15 V_{DD}, R_L = 100kΩ)

Item	Symbol	Condition	Min.	Typ.	Max.	Unit
Signal Delay Time	t _D		1.28		25.6	ms
Input Signal Frequency	f _i	f _{CP} = 40kHz, Output -3dB down	12			kHz
Input Signal Swing	V _i	THD=2.5%	0.5			V _{rms}
Insertion Loss	L _i	f _{CP} =40kHz, f _i =1kHz	-4	0	4	dB
Total Harmonic Distortion	THD	f _{CP} =40kHz, f _i =1kHz, V _i =0.25V _{rms}		0.4	2.5	%
Output Noise Voltage	V _{no}	f _{CP} = 100kHz			0.14	mV _{rms}
Signal to Noise Ratio	S/N	Weighted by "A" curve		77		dB

*1 Clock Pulse Waveforms

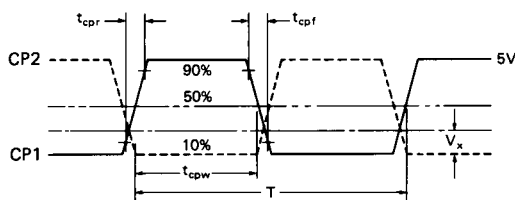

*2 T = 1/f_{CP} (Clock Period)

■ Terminal Assignments

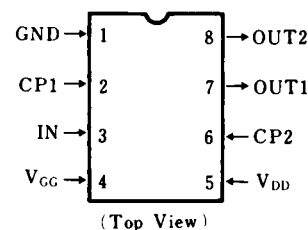

■ Circuit Diagram

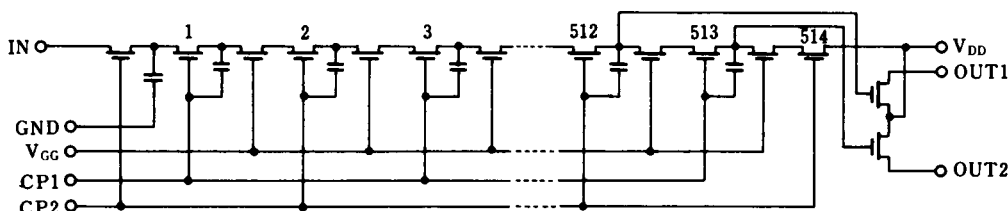

■ Typical Electrical Characteristic Curves

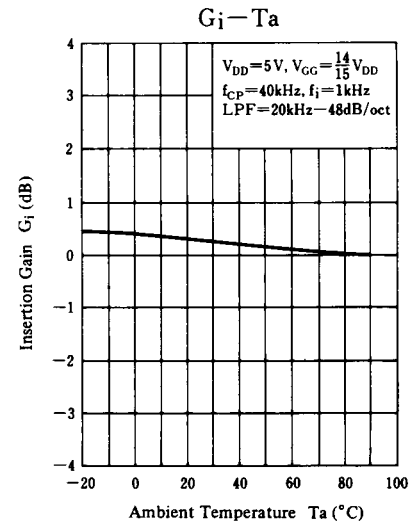
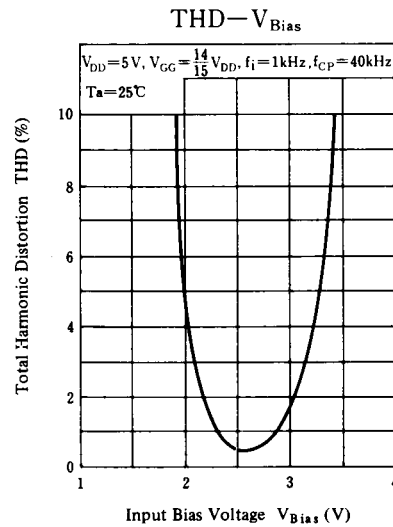
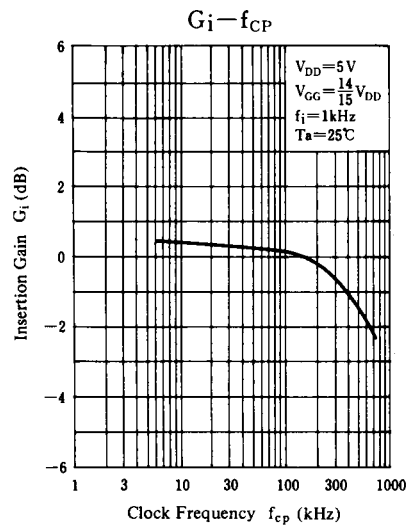
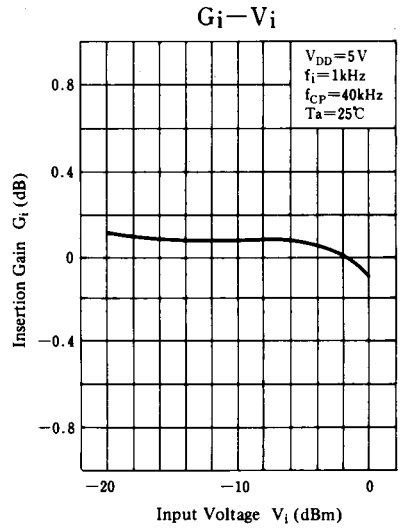
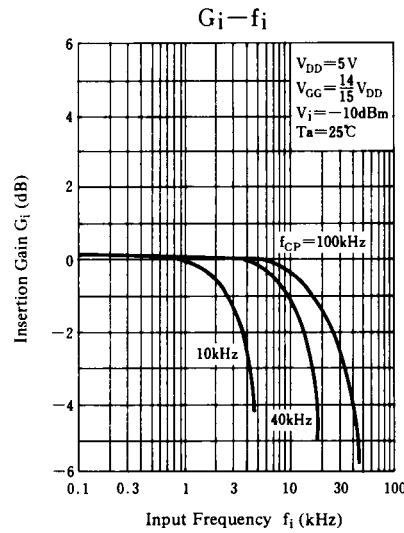
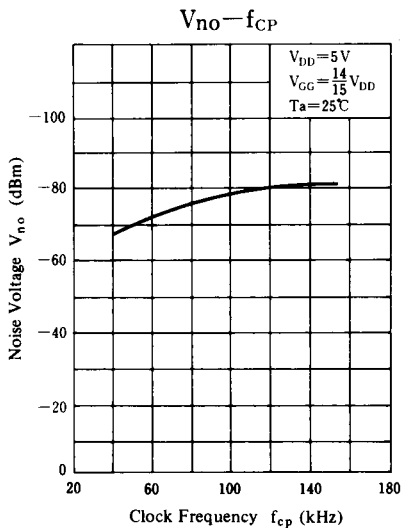
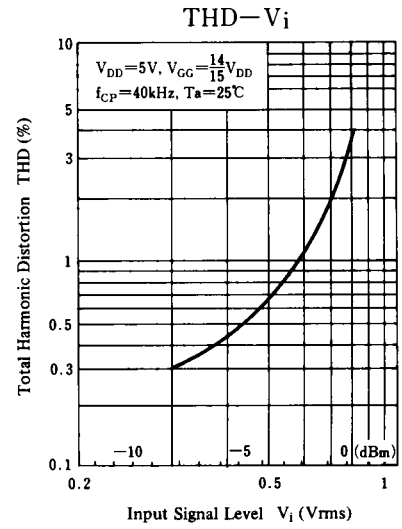
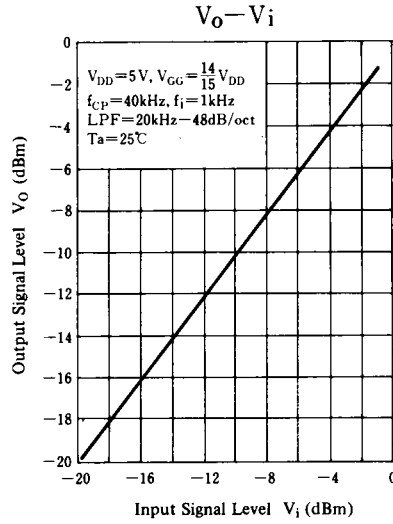
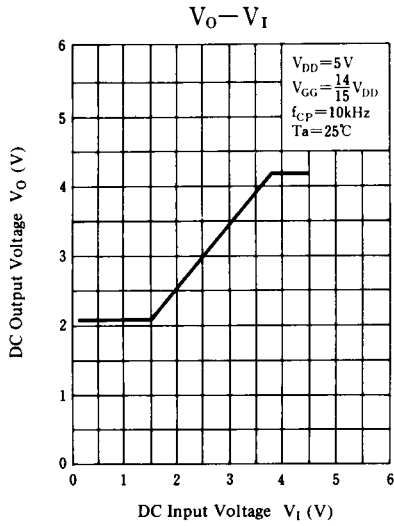

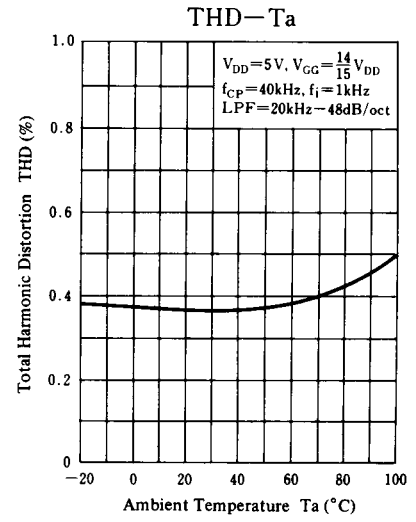
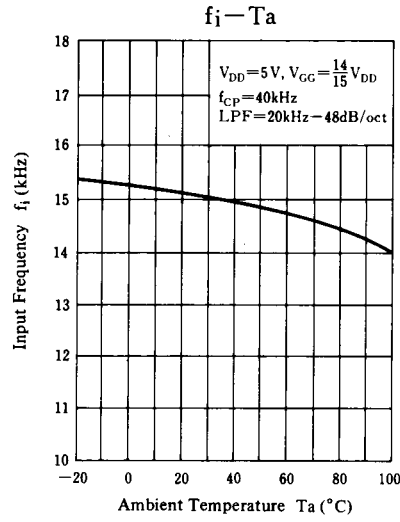
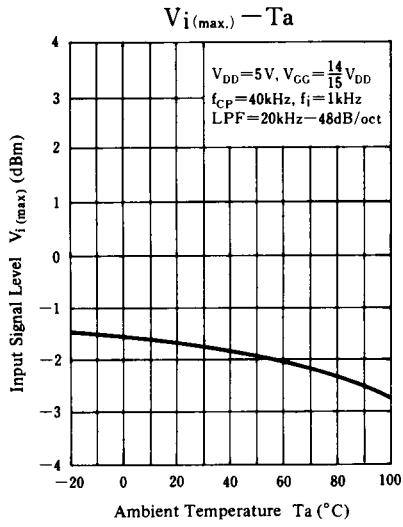

Supply Voltage Characteristics

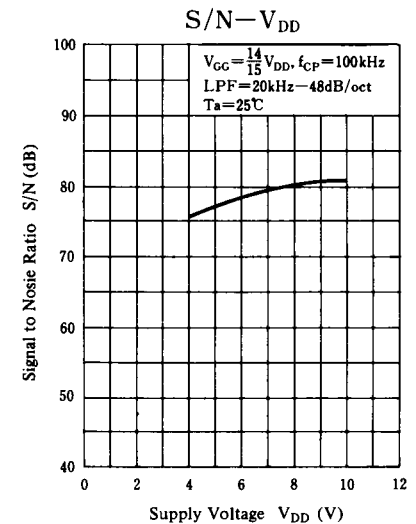
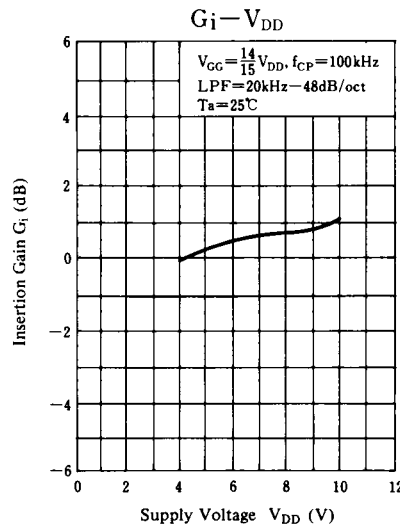
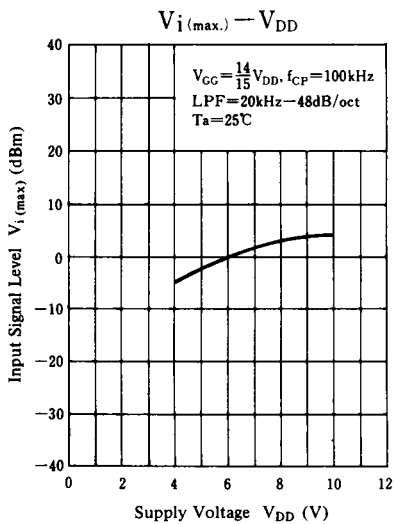
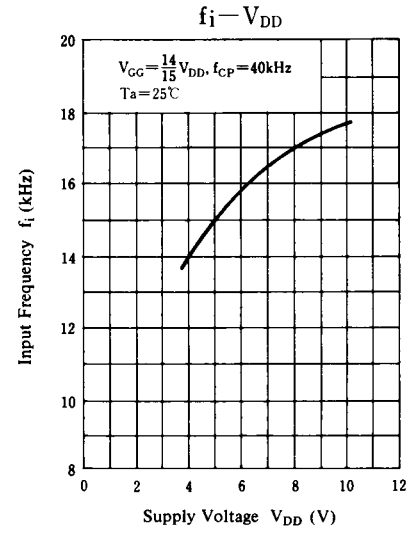
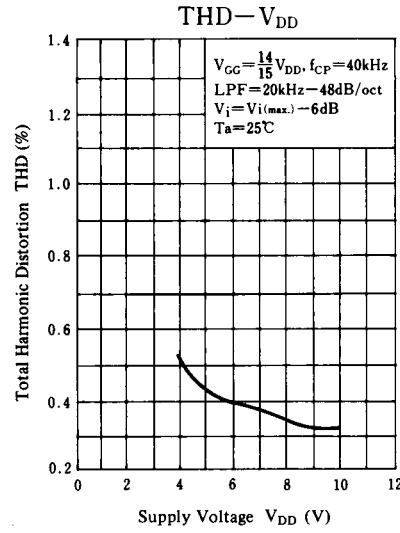
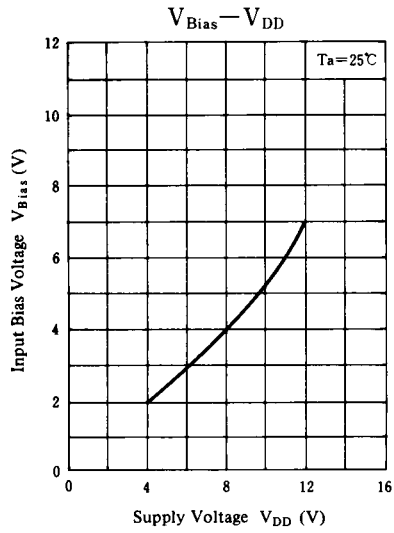

■ Application Circuit

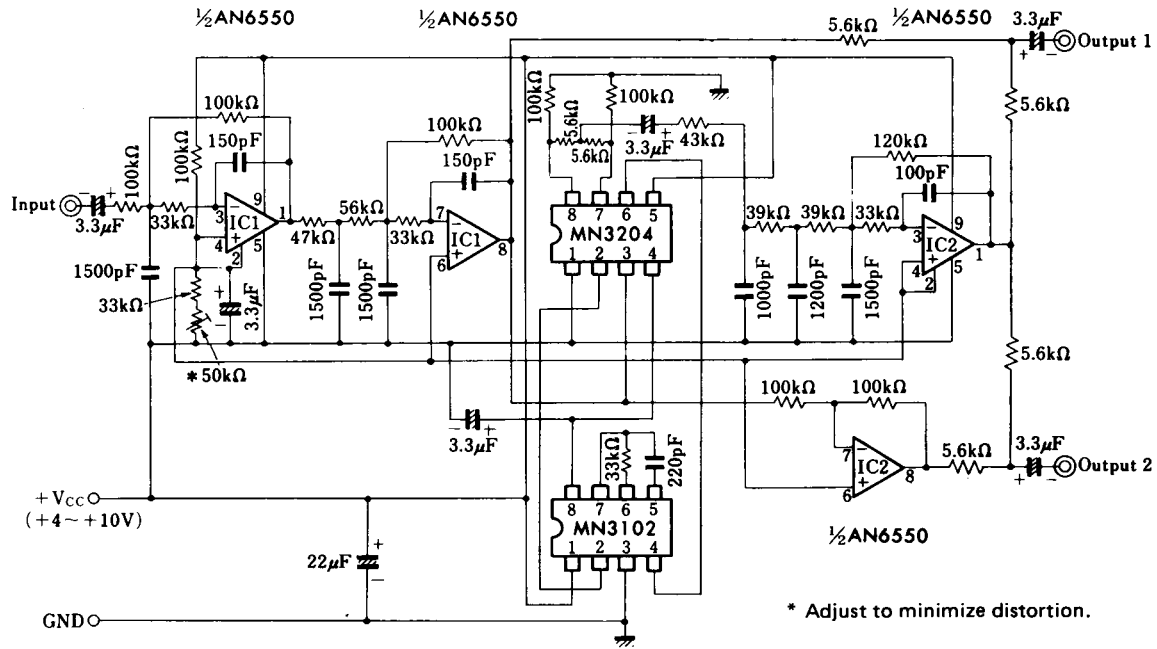

Echo Effect Generation Circuit (Signal Delay Over 10msec.)