

ARPQUADRA

PROGRAMMABLE SYNTHESIZER OWNER'S MANUAL

CONTENTS

INTRODUCTION.....	1	POLY SYNTH SECTION.....	14	OUTPUT MIXER/PHASE SHIFTER.....	34
INITIAL HOOKUP.....	2	VCF RESONANCE LFO		PHASE SHIFTER MOD	
GENERAL THEORY.....	3	LEAD SECTION.....	16	REAR PANEL JACKS.....	37
SIGNAL SOURCES MODIFIERS CONTROLLERS BLOCK DIAGRAM		WAVEFORMS PWM 2 VOICE ON HOLD/FLAT VIBRATO TRILL INTERVAL WRITE VCF RESONANCE ENVELOPE GENERATOR PORTAMENTO KYBD TRIG TOUCH SENSOR SEQUENCER		MEMORY LOADING.....	39
CONTROL MECHANISMS.....	8			MAINTENANCE	
BASS SECTION.....	10			TROUBLESHOOTING.....	40
ELEC BASS STRINGS BASS				PATCHES.....	41
STRINGS SECTION.....	12			SPECIFICATIONS.....	57
STRINGS AR SUSTAIN FOOTSWITCH HOLLOW WAVEFORM					

© Copyright March, 1979

ARP Instruments, Inc.
45 Hartwell Avenue
Lexington, MA 02173

Written by Michael Brigida

WARNING

To prevent fire or shock hazard,
do not expose this instrument
to rain or moisture.

INTRODUCTION

Congratulations on the purchase of your new ARP Quadra. The Quadra is one of the first synthesizers to incorporate a microprocessor in its design, allowing you to produce a powerful body of sound and quickly change to a dramatically different sound with just a touch of a switch.

One of the newest technological advances used in the Quadra is the tap-touch switch--an ARP exclusive. Each switch is an hermetically-sealed, electronically-latched, mechanical switch. This type of switch is extremely fast and highly resistant to failure.

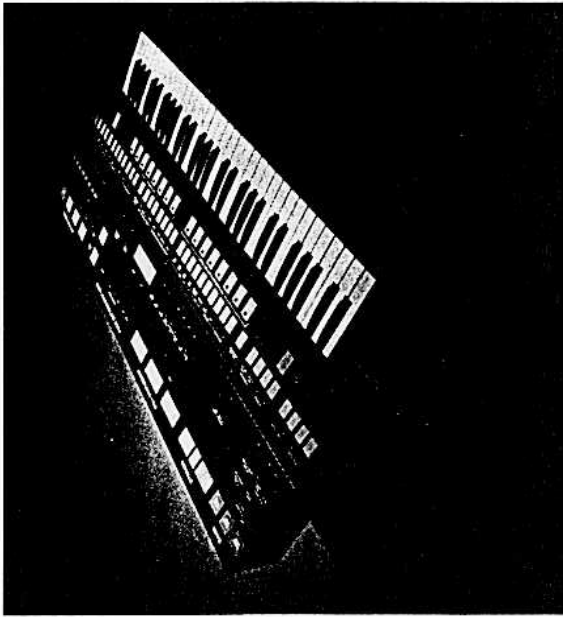

Another new and important design concept included in the Quadra is the user programmability of up to sixteen separate and distinct voices. Although fully programmed as shipped from the factory, you can edit, memorize, or erase any or all of the synthesizer parameters at any time.

As you delve into the basic operational theory of the Quadra, you will discover that an immense amount of thought was required in the creation of this instrument. You will find numerous subtle live-performance human engineered features for which ARP is famous.

This manual is intended to be your guide and should provide you with all the operational knowledge you need. If not, see your ARP Dealer or write or call ARP Instruments, Inc. for further assistance.

-Michael Brigida
Product Specialist
ARP Instruments, Inc.

INITIAL HOOKUP

Included with your Quadra are one foot pedal, one foot switch and a 110V standard power cord. Leave the footswitch and pedal unplugged for now.

Plug the female end of the power cord into the power receptacle located on the back of the Quadra. Plug the other end into a typical grounded power outlet. **CAUTION:** The tiny **LOAD/LOCK** toggle switch located on the back of the Quadra should be in the **LOCK** position before connecting the power cord.

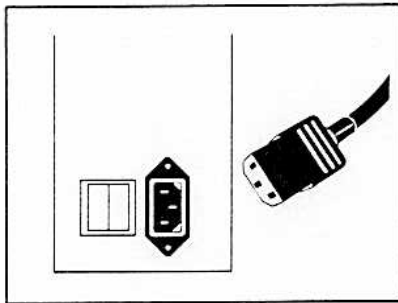
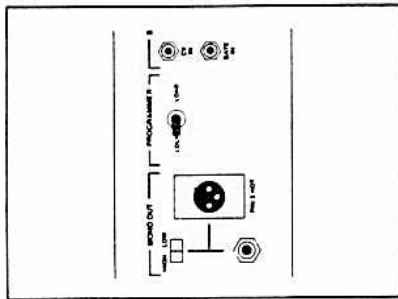

The Quadra is equipped with a unique power supply that is switchable from 110 volts to 220 volts. If you plan to use your Quadra abroad, consult your local Certified ARP Dealer or Service Center to have this modification performed.

Also located on the back of the Quadra are various input and output jacks. For an explanation of those jacks, turn to page 37. For listening and experimentation purposes, however, use only the 1/4" standard jack marked **MONO OUT**.

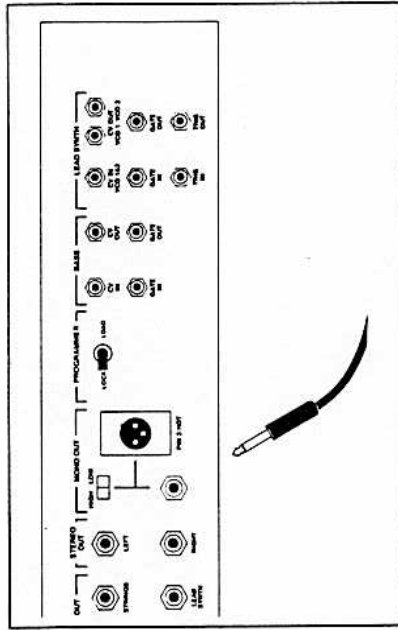

Like other synthesizers, the Quadra demands the use of a good quality, full range system. This is true because the instrument can produce frequencies from 20hz to 20,000hz. The better the sound system, the better the Quadra will sound. Using a typical good quality 1/4" to 1/4" audio cord, plug one end into the **MONO OUT** of the Quadra. The other should go into an input of the mixer that feeds your sound system.

The **HIGH/LOW** marking describes the two output levels achievable. **HIGH** level is generally used with any mixer that can attenuate this level enough to eliminate distortion and still provide the best signal/noise ratio. High level is always used in studio applications. Use the **HIGH** level if possible, but if distortion is heard--usually caused by overly sensitive mixer input channels--use the **LOW** level instead.

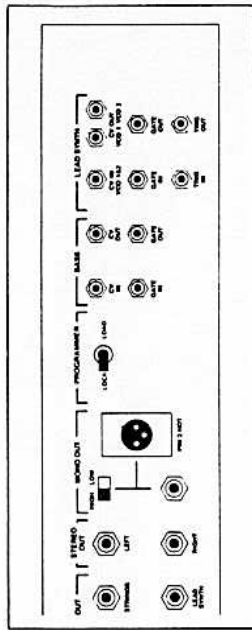

GENERAL THEORY

All synthesizers work in the same general manner. To get a full description of synthesizer function, ARP suggests you study our classroom text, **LEARNING MUSIC WITH SYNTHESIZERS** [Hal Leonard Publishing: Winona, Wis.].

Even with previous experience, many synthesizer terms and parameters vary from one synthesizer to another. The following will provide a brief description of terms and some basic understanding of synthesizer functions.

The electronic circuits in your Quadra fall into one of three basic categories:

1. **Signal Sources:** These are the "raw" pitched tones which will be modified or controlled by the other functions on the Quadra. The signal sources or voltage controlled oscillators (VCO) on your Quadra are the Bass VCO, Lead VCOs, and Polyphonic top octave Divider Oscillator.
2. **Modifiers:** Devices which "process" the raw signal from a signal source. These devices may be used to alter the timbre (tone quality) of a sound, or increase or decrease the amplitude of the sound. The modifiers on your Quadra include the Bass VCF and VCA, the String phase shifters, the Poly VCF and VCA, the Lead VCF and VCA, and the voltage controlled stereo phase shifter.
3. **Controllers:** Used to operate or "control" the output of signal sources or modifiers. For example, the keyboard is a controller which you use to tell the VCO which note to produce. Similarly, the LFO (sine wave) may be used to open and close the VCF to produce a tremolo effect. The controllers on your Quadra are the keyboard, (including the portamento), S/H, pedals, LFOs, Envelope Generators, Touch Sensor and Sequencer.

The following is a simple block diagram. Block diagrams are commonly used as visual aids to help you see the flow of information in electronic devices, such as the Quadra. From the diagram below, you will see that signals flow from the Signal Sources, through the Modifiers, and out to the amplifier. Controllers, however, are constantly being used to adjust the outputs of both Signal Sources and Modifiers.

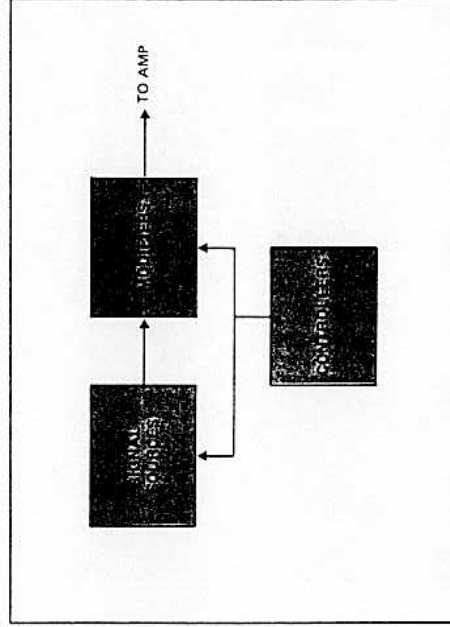

All mechanical instruments work in a similar way. A violin, for instance, has a vibrating string which would be a signal source. The vibrating string corresponds to an oscillator in your Quadra. The vibrations from the string are transmitted to the body of the violin which modifies the sound of these vibrations. The body of the violin is actually a mechanical filter and corresponds to one of the Voltage Controlled Filters (VCF) on the Quadra. It is the characteristic resonances of the body that give the violin its distinctive tone quality. The fingerboard, like the keyboard on your Quadra, determines the pitch of the sound. The movement of the bow, like the ADSR envelope generator, determines the attack and decay characteristics of the sound.

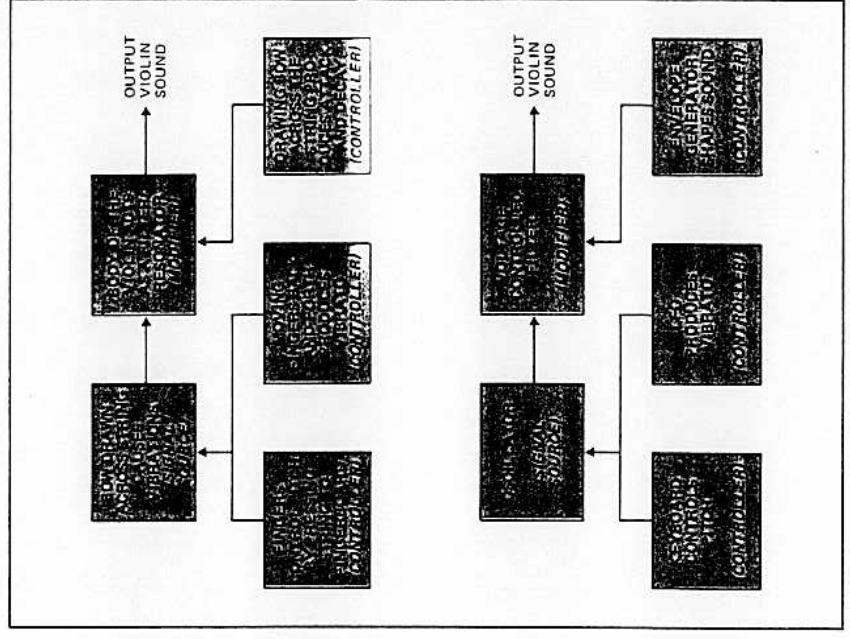

SIGNAL SOURCES

The voltage controlled oscillators and divider oscillator on your Quadra produce electrical waveforms (sawtooth, pulse, and square waves) which are used to create a wide range of sound timbres. If a signal generated by an oscillator has the same waveform as a sound created by a traditional instrument, both will have a similar sound.

Different waveforms have different sounds. Your Quadra is capable of producing the following raw waveforms.

SAWTOOTH WAVE: Full, Brassy



SQUARE WAVE: Hollow, Clarinet-like



PULSE WAVE: Bright, Nasal



MODULATED PULSE WAVE: Rich, Chorus-like



MODIFIERS

Modifiers are electronic devices that can process a signal and change its sound. Consequently, a modifier must have an input and an output. A tone control on a Hi-fi set is a simple modifier since it changes the nature of the sound signal that passes through its circuitry.

The Voltage Controlled Filter (VCF) is the most important modifier on any synthesizer. The VCF is responsible for taking the raw signals from the VCOs and shaping them into useful musical sounds.

The VCFs in your Quadra are technically called "Low Pass Filters." Low-pass means that the filter will pass all audio frequencies below a certain point determined by the setting of the VCF CUTOFF slider, and will filter out all frequencies above this point.

LOW-PASS FILTER DIAGRAM

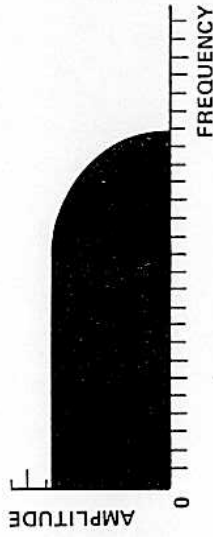

(Colored area indicates frequencies passed by the filter. The point at which the filter no longer passes any frequencies is called the Cutoff Point.)

CONTROLLERS

The Voltage Controlled Amplifier is responsible for modifying the amplitude (loudness) of the sound which is passed to it from the VCF. Just as the VCF is used to change the timbre or harmonics of a sound, the VCA is used to change the volume.

Controllers are devices on the synthesizer which are used to create electrical signals which in turn control modifiers or sound sources on the synthesizer. For instance, the most obvious controller on the Quadra is the keyboard. The keyboard produces a voltage (called Control Voltage or CV) which causes the VCO to produce different notes depending on which key you depress.

ENVELOPE GENERATORS are very versatile and flexible functions on your synthesizer. The Envelope Generator is used to "shape" the sound you have created, from start to finish. The ADSR ENVELOPE GENERATOR produces no sound of its own, but is used strictly as a controller, in much the same way as the LFO is used. Each time a note is pressed on the keyboard, the keyboard generates a "trigger" signal that initiates an attack from the ADSR. A complete cycle of the ENVELOPE GENERATOR looks like this:

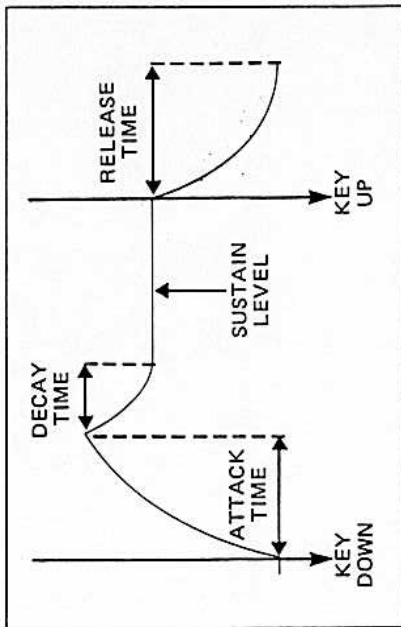

When a key is depressed, the ADSR produces a rising voltage. This signal is called the ATTACK. The ATTACK signal rises at a speed which you determine with the setting of the ATTACK slider. When the ATTACK slider is set at minimum, it produces an immediate signal. When the slider is set at maximum, the signal takes about four seconds to reach full strength. When the ATTACK signal has reached its peak, it turns around and begins descending at a speed determined by the DECAY slider. The signal will continue to descend until it reaches the level selected by the SUSTAIN slider.

The SUSTAIN slider sets a level at which the signal will be maintained as long as the key is held down. As soon as the key is released, the signal will again begin to fade at a speed selected by the RELEASE slider. The RELEASE signal is initiated only when the key is released. At the minimum setting, the RELEASE slider will produce an immediate decrease in the signal. At maximum, it takes about five seconds.

The Envelope Generator may be used to control the volume of a sound (the most common application), or it may be used to open and close the filter, modulate pulse width, or modulate the phasor.

The four ADSR sliders correspond to the mechanics of almost all sounds. You may use them to set up a percussive ATTACK (such as a piano), or a slow ATTACK (such as a cello). You may have an immediate DECAY (steel drum) or a long DECAY (trumpet). The SUSTAIN level of an organ is very high, while a xylophone has no SUSTAIN level at all. You may set up an immediate RELEASE such as a flute might have, or a long RELEASE like rolling thunder.

VARIOUS ENVELOPES POSSIBLE WITH AN ADSR ENVELOPE GENERATOR

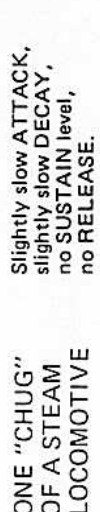
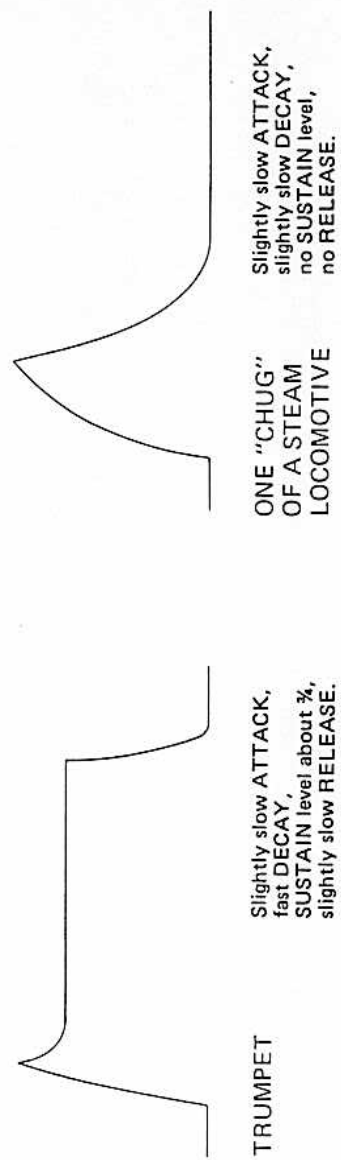
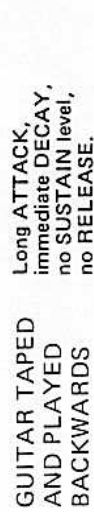
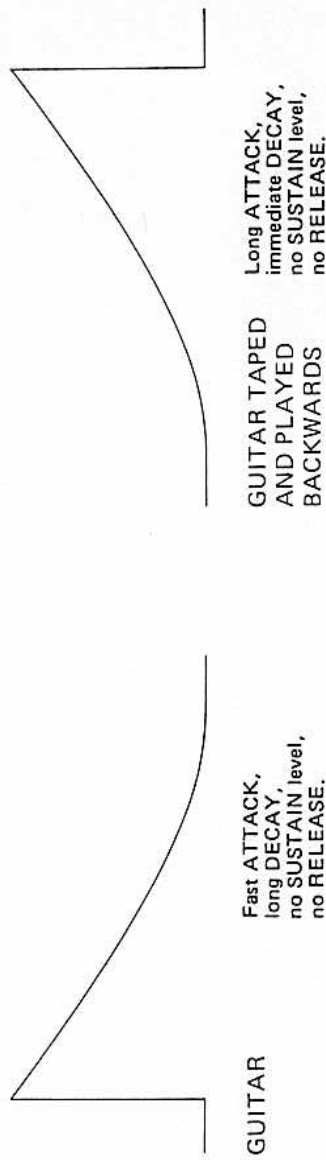
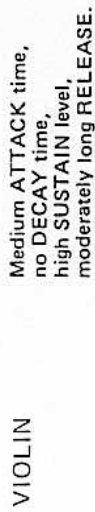
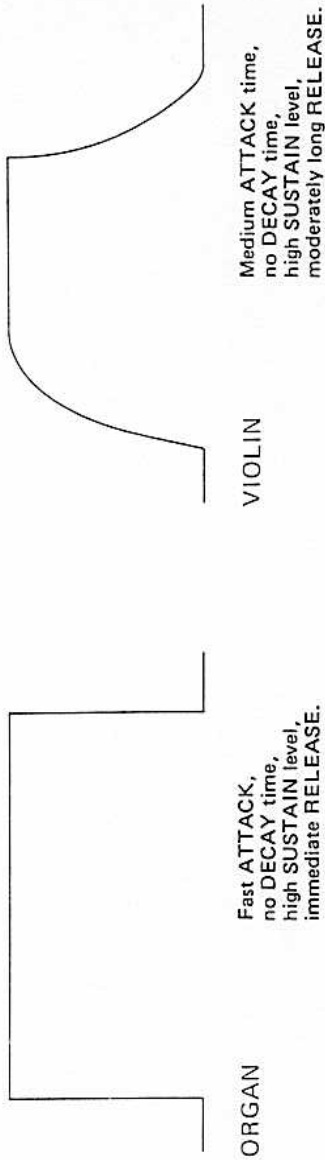

BLOCK DIAGRAM

Now that you have some understanding of the principles involved in synthesis; i.e., tone generation, filtering, envelope and voltage control, etc., review the

following simplified block diagram which represents the Quadra. (Horizontal arrows indicate audio paths, vertical lines indicate control paths.)

Obviously there is much more circuitry in the Quadra than indicated here, but you should be able to understand the "flow" of these functions.

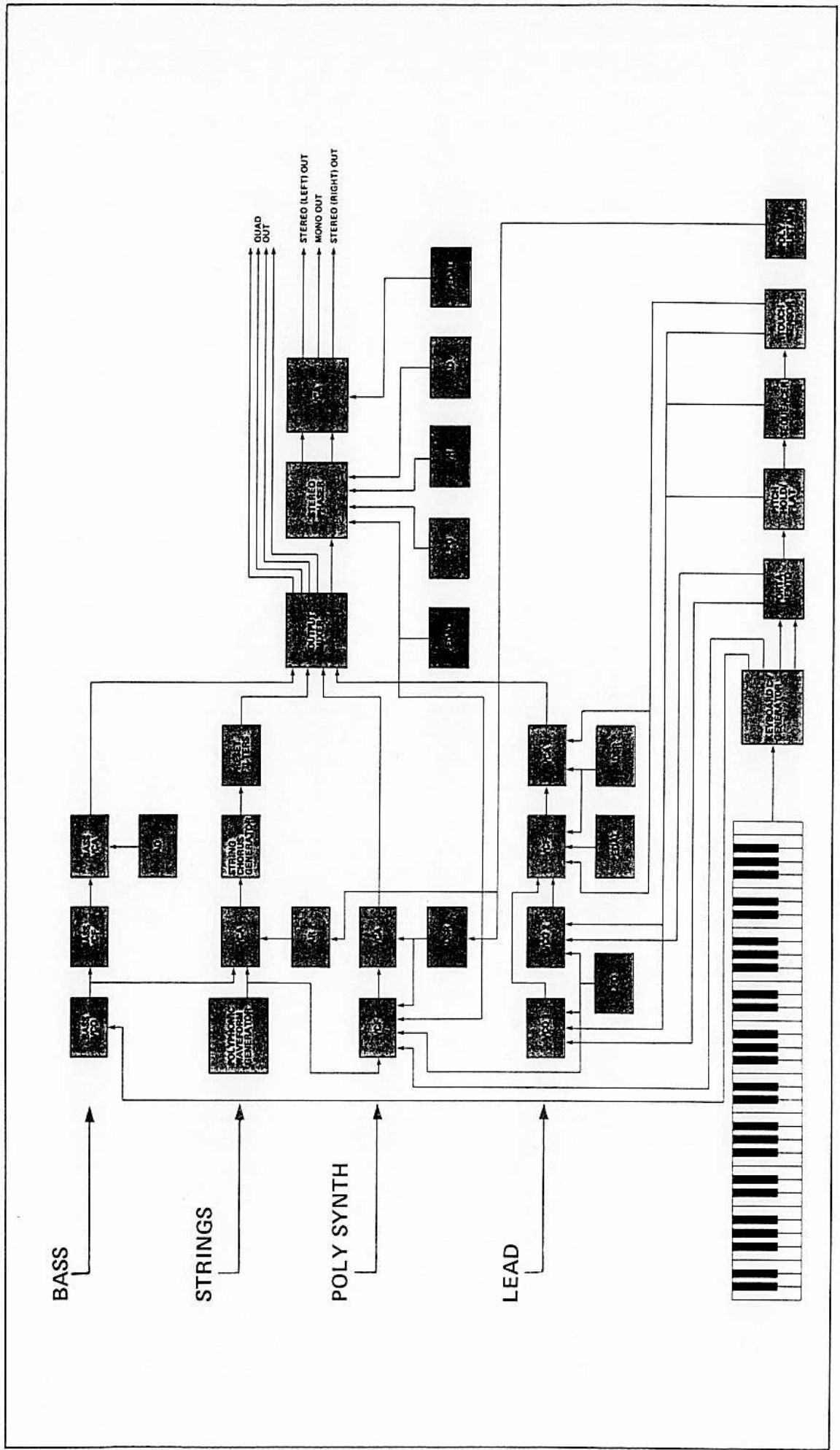

CONTROL MECHANISMS

Now that you have an idea of synthesizer basics and the "flow" diagram, let's discuss the primary controls and the operating rules associated with them.

Scan the face panel of the Quadra and see that there are three primary types of controls: (1) sliders, (2) voice location touch switches numbered 1 through 16, and (3) preset/variable select switches (Figure A).

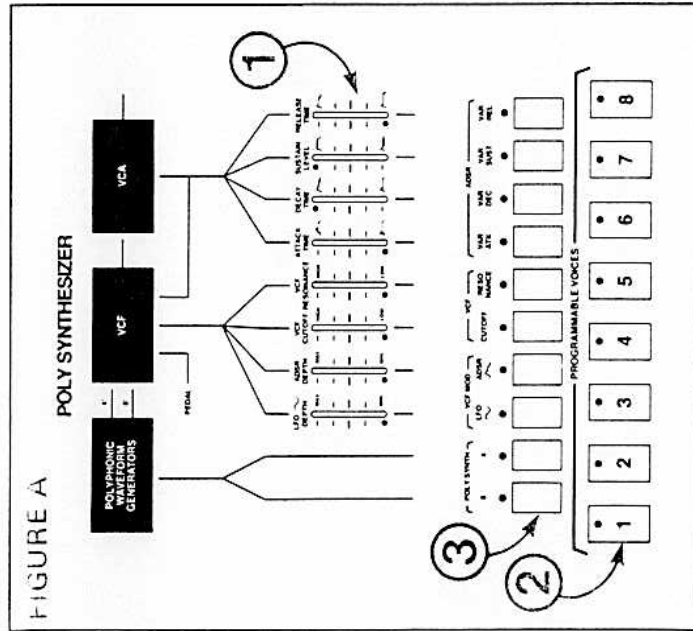

Simply put, the voice location switches (1-16) will contain completed sounds or patches, each of which is automatically memorized by the computer. The preset/variable select switches (all of the remaining tap-touch switches located above 1-16) allow the musician to select either a factory preset or slider/variable position.

The computer does not memorize different slider positions, but does memorize whether the different parameters are at the preset setting or variable setting. To clarify this, try the following experiment. Remember to keep the small **LOAD/LOCK** toggle switch on the back of the Quadra in the **LOCK** position in order to prevent erasing factory patches.

1. With your Quadra plugged in and switched on (the audio cord is not necessary for this experiment), tap any of the sixteen voice switches and notice the different combinations of light on/light off switches. When off, these designate factory presets.
2. Tap Voice: No. 1. Locate the "Strings" block on the face panel and notice that two of the four switches in that section are designated **STRINGS AR**. Also notice the two variable sliders located above these switches. Next to these sliders are two small orange dots.

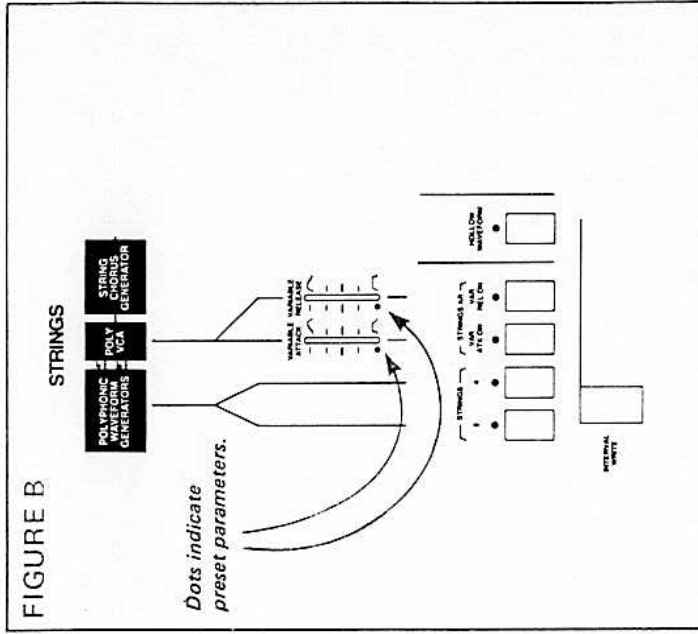

3. Tap the two **STRINGS AR** switches to make the two LEDs go out. The AR parameters are now at a preset setting indicated by the small dots (Figure B). Hence, fast Attack, fast Release.

4. Tap the AR switches again so that the LEDs are on. Now the sliders above them become operative providing variable control.

Different combinations of Light On/Light Off will provide many varied settings. All of the preset/variable select switches on the Quadra work in this exact same manner. More programming information is provided later in this manual.

OCTAVE switch-
Used to transpose the BASS section down one octave.

VARIABLE OPTION sliders-
When you have chosen the variable option on the touch switches below, you may set the slider parameters yourself. If you have chosen the preset option, the small dot next to the slider shows the preset parameter.

TUNE controls-
Used for tuning LEAD VCOs

LFO section-
Used for tremolo on POLY SYNTH section, vibrato on LEAD section.

BASS TUNE slider-
Used to tune the BASS VCO

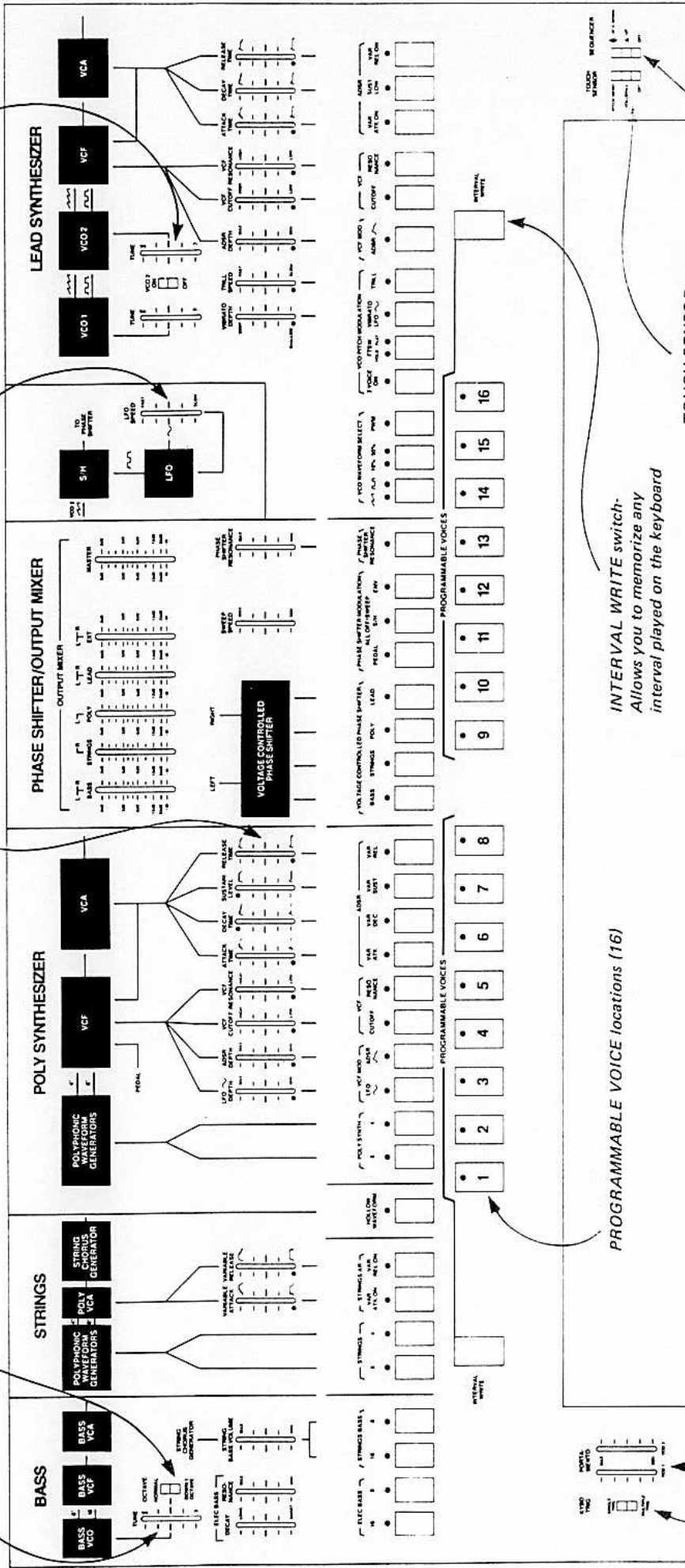

TOUCH SWITCHES-
Most of these switches allow you to choose between a factory preset value and a slider setting you set for yourself. Some of them allow you to choose between two possible selections ("mutually exclusive" switches).

PORTAMENTO sliders-
Allow you to set two Portamento rates (one for each VCO in the LEAD section)

KYBD TRIG switch-
Controls triggering of POLY SYNTH and LEAD sections

PROGRAMMABLE VOICE locations (16)

INTERVAL WRITE switch-
Allows you to memorize any interval played on the keyboard

TOUCH SENSOR-
Affects upper 3 octaves of the keyboard

SEQUENCER-
Arpeggiates any intervals played on keyboard

BASS SECTION

The Bass section of the Quadra is actually a monophonic mini-synthesizer by itself, incorporating its own tunable VCO, filter, and envelope generator. Two dramatically different bass sounds are available from this section. 1) a type of electric bass sound, and 2) an acoustic ensemble of orchestral basses. The footage switches denote pitch range choices and both the electric bass and orchestral bass can be simultaneously transposed down still another octave for a true 32-foot pedal tone.

When any of the bass voices are turned on, a keyboard split is created. The keyboard range of the BASS synthesizer is from C1 to B2.



ELEC BASS

Let's experiment. Plug in the audio line to your sound system as described earlier. Place the face panel controls at the settings shown in Figure C. All other sliders should be in the middle position.

With the exception of the dual function (red and green) or "mutually exclusive" LEDs, all other LEDs should be out.

1. Tap the 16' ELEC BASS switch and play a bass line on the lower part of the keyboard. Notice how the "bass" slider in the output mixer controls volume as well as the master. Try using the 8' ELEC BASS sound, then try it in combination with the 16'.

2. Located above these switches are two sliders marked DECAY and RESONANCE. Using the 16' switch, move the DECAY slider all the way down and play a line on the keyboard. Notice that this creates a plucked or punchy articulation. Remember: decay occurs only while a key is depressed and not on the release of a key.

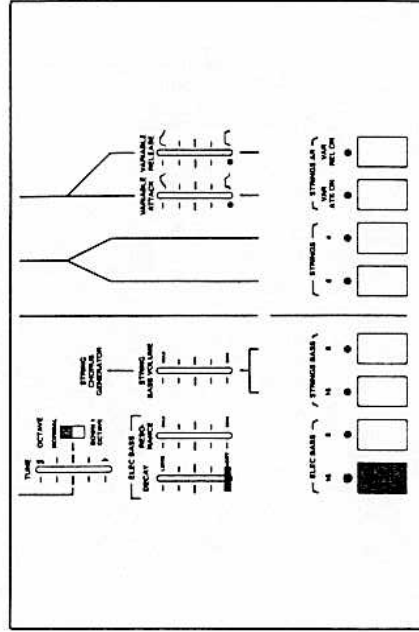

3. The RESONANCE slider can be used to create a funky bass line. Try experimenting with different slider combinations of decay and resonance until you arrive at one or two settings you like most.

STRINGS BASS

As stated earlier, the STRINGS BASS sound creates an entirely different tonal character. Refer to the block diagram on Page 7 and notice that the BASS VCO can be routed into the string chorus generators. This is done automatically when either or both of the 16' or 8' STRINGS BASS switches are selected. Tap the 16' STRINGS BASS and notice that the volume of this sound is not only controlled by its own STRING BASS VOLUME CONTROL, but is ultimately controlled by the STRING slider volume control in the OUTPUT MIXER. Because of the fact that the strings bass is routed through the STRING VCA, the STRINGS AR controls articulation of the STRINGS BASS. AR is explained in the next section.

Both the ELEC BASS and STRING BASS sections may be tuned with the TUNE slider. Immediately to the right of this slider is the OCTAVE switch, which allows you to transpose the Bass section down one complete octave.

Experiment with different combinations of bass voices. Later on in this manual you will learn how to use this voice in combinations with the Strings, Poly and Lead.

FIGURE C

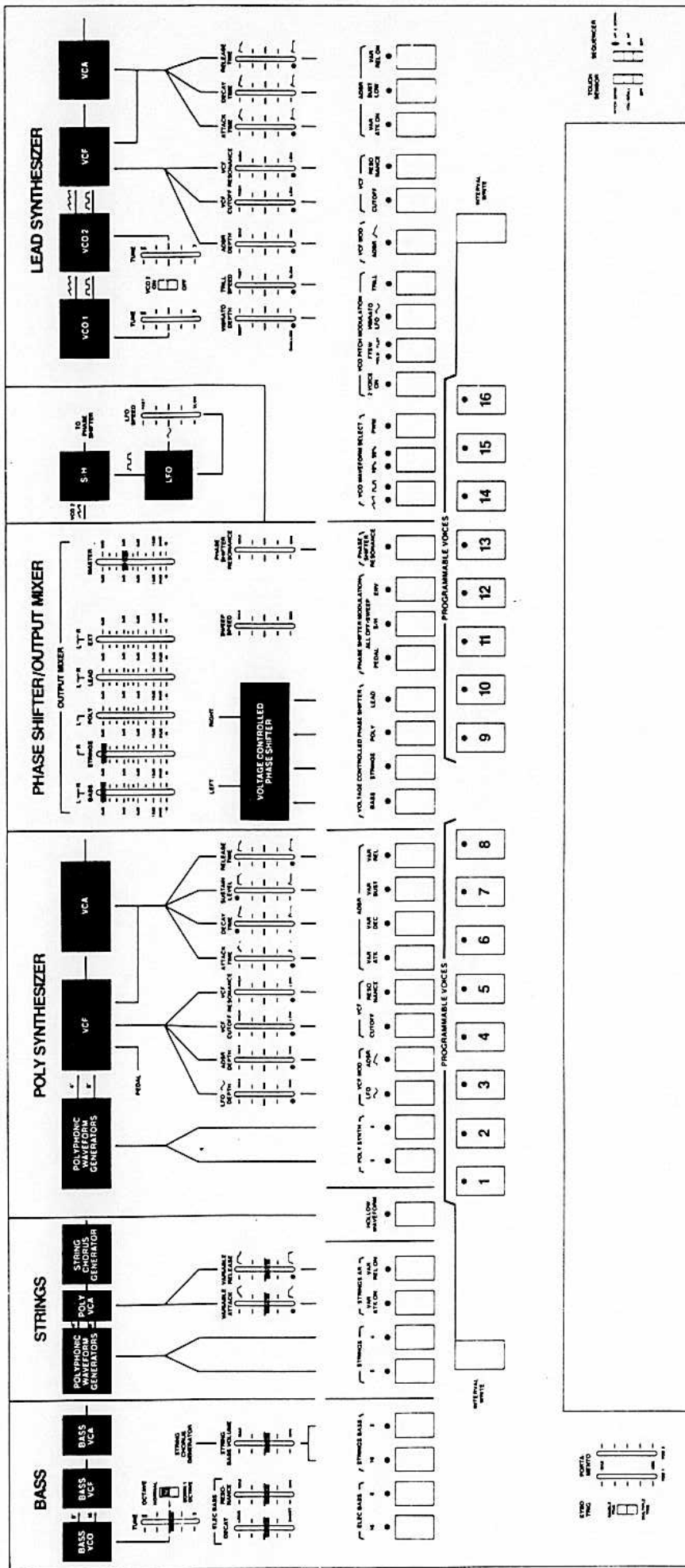

STRINGS SECTION

STRINGS AR

The STRINGS Section on the Quadra is a full orchestral voice in itself. Dramatic differences in the strings can be achieved simply by varying keyboard technique. If, for example, "open" voiced chords are used, a rich expansive body of sound will be produced. On the other end, if tight "tone clusters" are played up high on the keyboard, a silky, ethereal effect will be produced. Therefore, keyboard technique is very important in the creation and duplication of authentic orchestral sounds.

The STRINGS section is active over a 4-octave range, starting at C2.

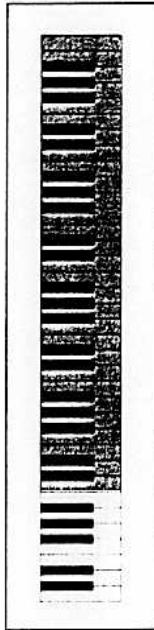

Use face panel settings shown in Figure C.

1. Tap 8' STRINGS, VAR ATK ON, and VAR RELEASE ON. Play a musical line on the upper half of the keyboard and listen to the silky viola-like quality of sound.
2. Now tap 4' STRINGS and listen to the brighter violin-like timbre produced. Both 8' and 4' strings can be played polyphonically (any number of keys can be depressed at once).
3. Now tap the AR switches so that their LEDs go out. Play a musical line and notice that the strings sound choppy; i.e., fast Attack and Release. This type of articulation can be used when playing fast musical lines.

Experiment with different combinations of string footages and articulations and, while playing, try to think like a violinist.

SUSTAIN FOOTSWITCH

Remember to play "open voicings" using the 8' switch and "clusters" using the 4'. Also, if a long release is desired in your playing technique, plug your footswitch into the jack on the back of the Quadra marked FOOTSWITCHES-POLY SUSTAIN.

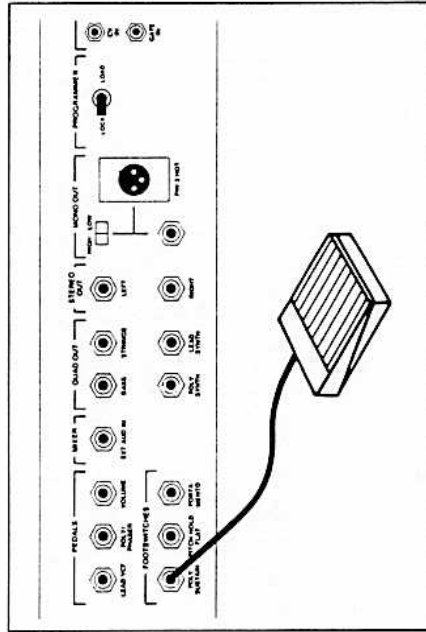

Depressing this footswitch automatically disables any RELEASE slider setting (whether preset or variable) and sets the it at maximum RELEASE time. This footswitch works for both the STRINGS and the POLY SYNTH sections of the Quadra.

Now set up a patch using 16' STRINGS BASS, 8' STRINGS and VAR ATK and RELEASE. Try playing a single note on the bass and an "open" chord on the strings. Notice how the two string footages blend to create a simple "layering" effect, much the same as is produced by a real orchestra. Detune the bass slightly by moving the BASS VCO tune control. This gives the effect of added realism creating the illusion of two sections. Experiment with different combinations of strings and bass and try to create a good balance between the two.

HOLLOW WAVEFORM

The HOLLOW WAVEFORM affects both the STRINGS and POLY SYNTH sections. Depressing this switch will change the basic raw waveform of the STRINGS and POLY SYNTH from a sawtooth to a square wave, thereby changing the complete character of the sound. Play your string parts again, and this time use the HOLLOW WAVEFORM. Note how the strings lose their classic orchestral character and take on a new, totally different sound. This same dramatic effect takes place when the HOLLOW WAVEFORM is selected with the POLY SYNTH section.

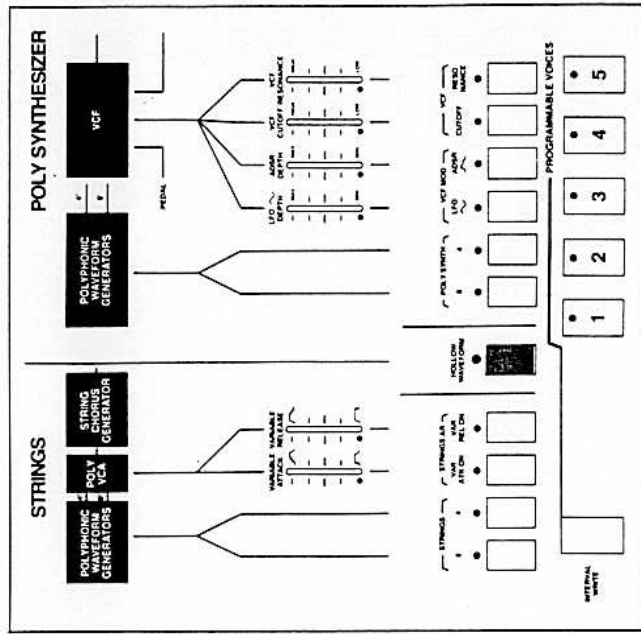
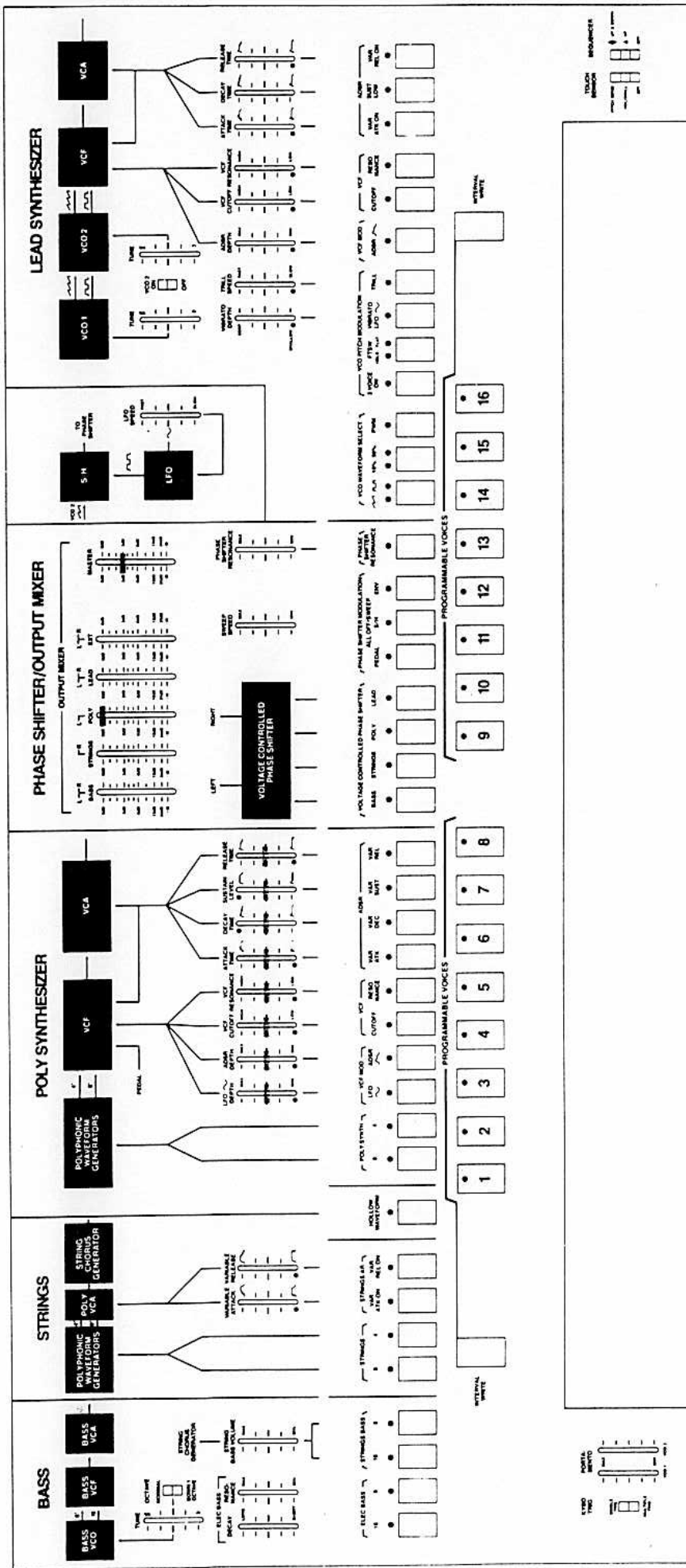

FIGURE D



POLY SYNTH SECTION

VCF

The POLY SYNTH section will allow you to produce authentic sounding piano, vibes, brass and other impressive synthesizer effects. Like the STRINGS, the POLY SYNTH can be played polyphonically. In fact, both the STRINGS and the POLY SYNTH derive their sound from the very same polyphonic tone generator and have the same keyboard range. However, when a BASS voice is selected, the POLY SYNTH range is reduced to 3 octaves, and the two do not overlap, as the STRINGS section does.

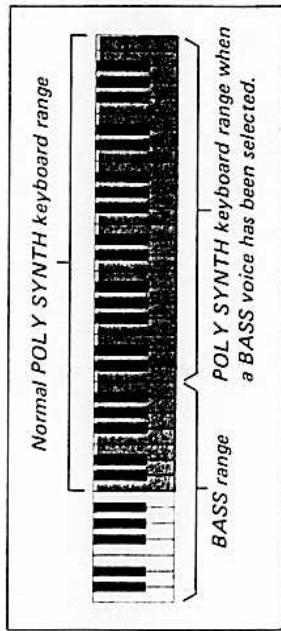

Set up the Quadra face panel as shown in Figure D.

1. Tap the 8' and 4' switches so that the LEDs above them are lit. The 8' and 4' switches can be used individually or simultaneously and normally produce polyphonic sawtooth waveforms, except when the HOLLOW WAVEFORM has been selected.

2. Tap the switch marked ADSR on the brackets marked VCF MOD. This operation allows the ADSR to open the VCF according to the position of the ADSR DEPTH slider. Play a few notes on the keyboard and vary the ADSR DEPTH slider. Notice how the sound appears to get brighter and louder towards the top and mellow and softer towards the bottom of its travel.

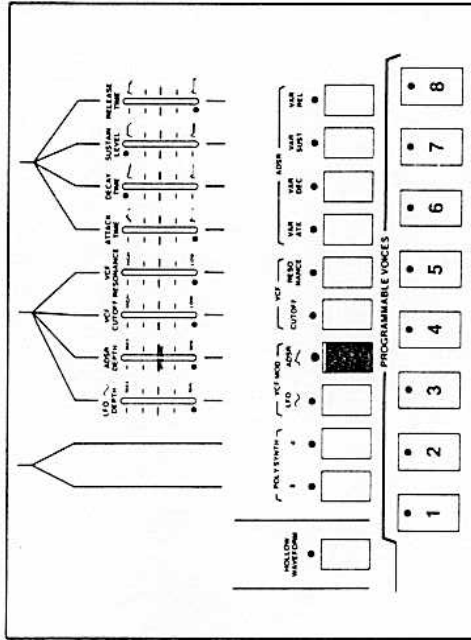

3. Experiment with the four ADSR controls, and try to familiarize yourself with their function. NOTE: The Release slider will not produce a long release time unless the Variable Release slider in the Strings section has been selected, and the slider raised to the top position.

4. Always remember, that the four ADSR sliders continually generate articulation parameters even though their LEDs may be off, as indicated by the orange dots. Without moving the sliders away from their midpoint position, try creating different envelopes with different combinations of LED on, LED off.

5. Once again tap the ADSR DEPTH switch so that the LED goes out, indicating zero control of VCF by ADSR.

6. Now tap the switch marked VCF CUTOFF. This procedure allows you to manually open and close the VCF via the slider if a static filter mode is desired. At this point the VCA is being opened and closed by the ADSR. With VAR ATK and VAR RELEASE on, switch back and forth from ADSR MOD switch and CUTOFF switch and listen to the difference between dynamic filtering and static filtering. A static filter is generally useful when a piano or harpsichord type of timbre is desired; whereas the ADSR is essential in creating a brass sound.

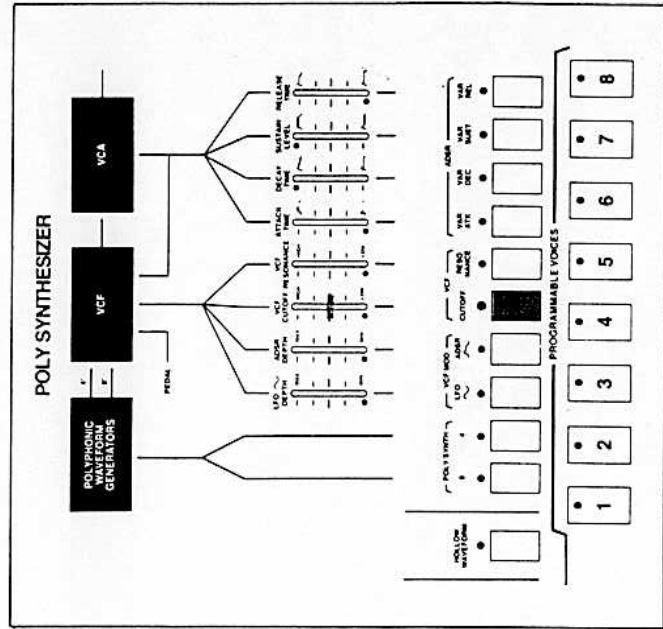

RESONANCE

RESONANCE is a useful sound tool and is essential for creating funky wah-wahs and other classic synthesizer effects.

1. With VAR ATK, VAR REL, and ADSR on, tap the RESONANCE switch on and play a few notes on the keyboard. Listen to the characteristic "wow" sound that is produced. Try using different amounts of RESONANCE until you arrive at the setting that you prefer most.

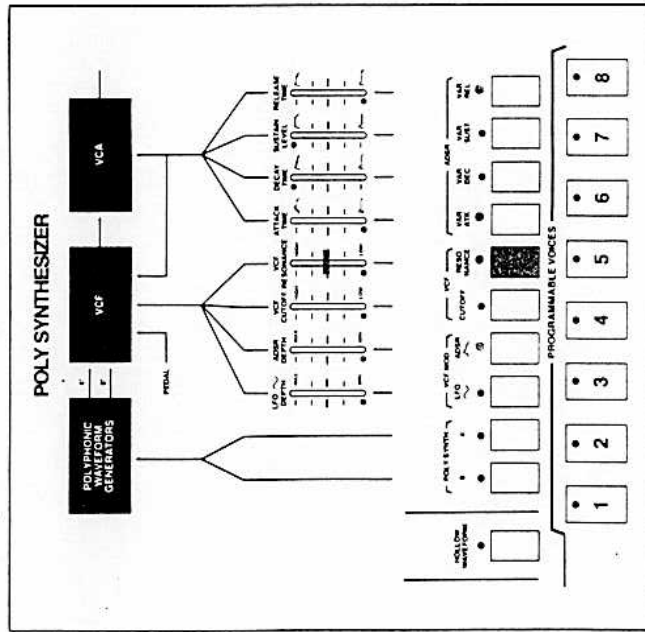

Resonance is also useful when you use the pedal with the POLY SYNTH. On the back of the Quadra, locate the jack marked PEDALS-POLY/PHASER, and plug the pedal into this jack. Now play a line on the keyboard while moving the pedal up and down. This should produce a pedal-controlled wah, useful in creating funky type sounds. You will notice that this pedal does not modulate the resonance, but rather opens and closes the filter. The resonance function serves to emphasize this operation. This same pedal may be used to open and close the phaser, as we will explain later.

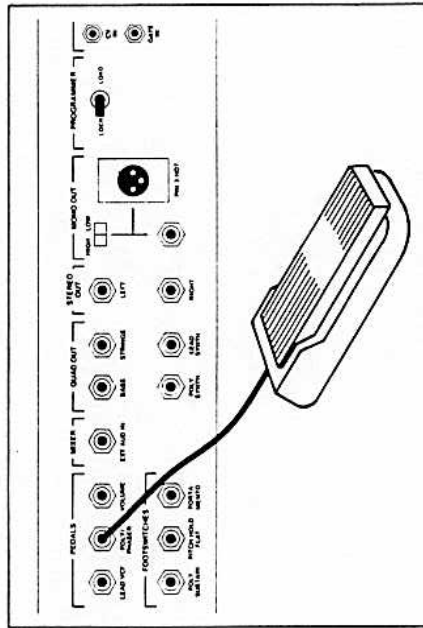

2. Now tap the ADSR LED off and the VCF CUTOFF LED on. Play a line on the keyboard and note how resonance can accent harmonics, thereby providing a different type of timbre.

LFO

One last slider involved in the VCF MOD section is the LFO (Low Frequency Oscillator). This is basically used as a tremolo control, the speed of which is controlled by the LFO SPEED slider located to the left of the LEAD SYNTHESIZER section on the face panel. Tremolo is useful for creating authentic flute or vib sounds as well as wild synthesizer effects. Try using this effect with the patches already described.

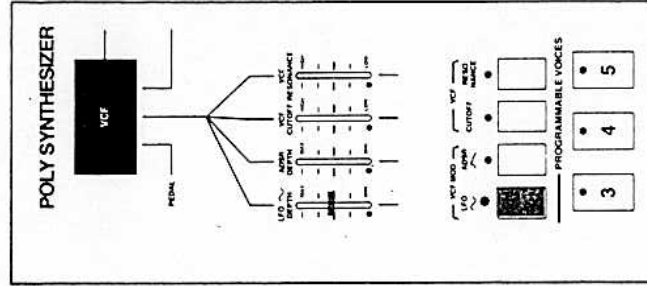

LEAD SECTION

The LEAD SYNTHESIZER Section, like the BASS SYNTHESIZER, is by itself a complete synthesizer. If it were not contained in the Quadra but was in fact a separate physical unit, its features would rival those of other lead synths in its class.

Basically, the LEAD SYNTH is a two-oscillator, duophonic synthesizer capable of creating exciting musical effects by use of its own VCF and highly complex envelope generator. The LEAD SYNTH can be played over the entire range of the keyboard, except when a BASS voice has been selected, when the LEAD synthesizer is reduced to a 3-octave keyboard range.

However, the LEAD synthesizer may be transposed to any key in the audio range, as we will explain later.

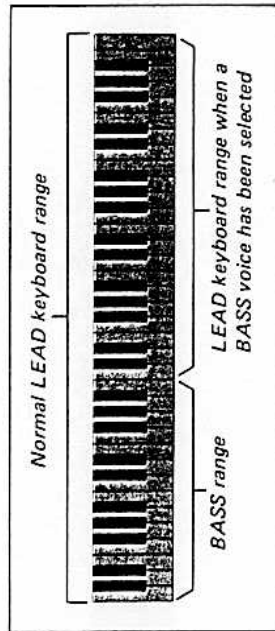

Many controls and principles are associated with this section; therefore, we will examine each individually, then together. First, tap voice location No. 8 and set up the face panel as shown in Figure E.

WAVEFORMS

The LEAD SYNTH offers you a choice of five raw waveforms: sawtooth, square, 10% pulse, 10% modulated and 50% pulse modulated.

1. Tap the switch marked SAWTOOTH, SQUARE WAVE so that the SAWTOOTH LED is lit, and the ADSR switch so that its LED is lit.
2. Find the VCO ON/OFF switch located between the VCO tuning sliders, and move it to the OFF position. (This will disable VCO 2 allowing you to monitor only VCO 1.)

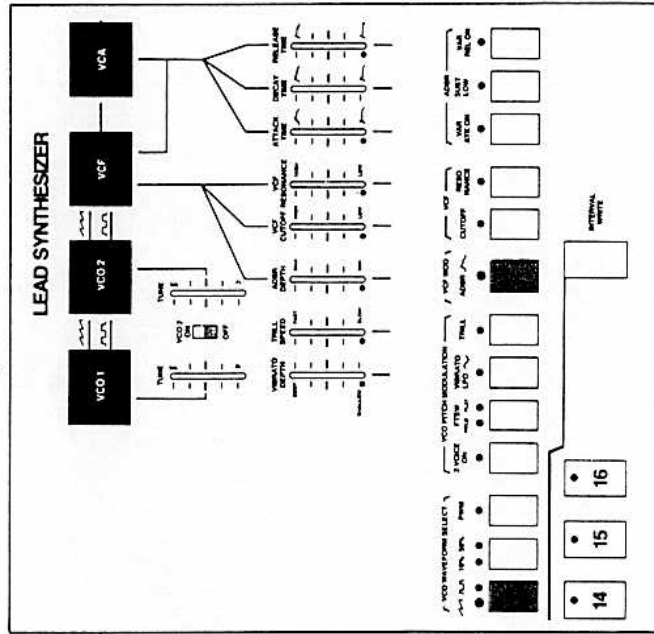

3. Play the keyboard and listen to the brassy quality of the sawtooth wave.
4. Tap the SAWTOOTH, SQUARE WAVE switch again and notice that the SQUARE WAVE LED lights. This is called a dual function or mutually exclusive switch. Play the keyboard again and notice how the sound changes from a brassy timbre to either a "reedy" or "hollow" timbre, depending on the setting of the switch labelled "10% - 50%."
5. Switch back and forth from 10% to 50% and listen to the sound change from a nasal to a hollow timbre.

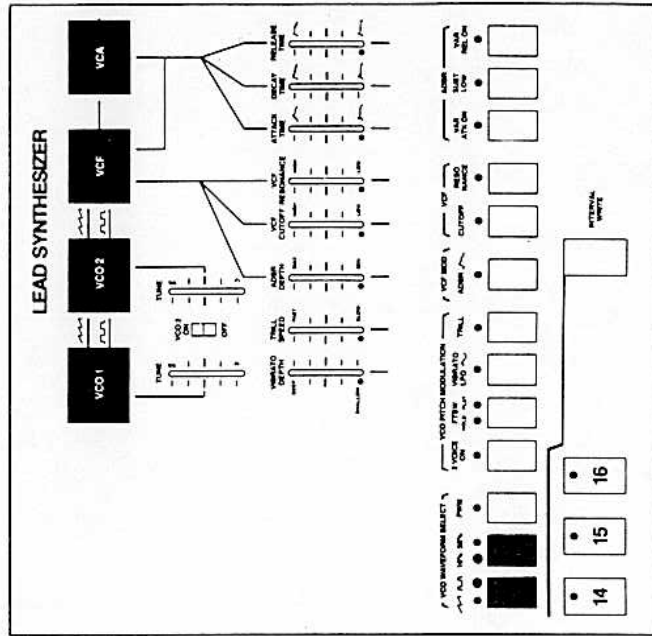
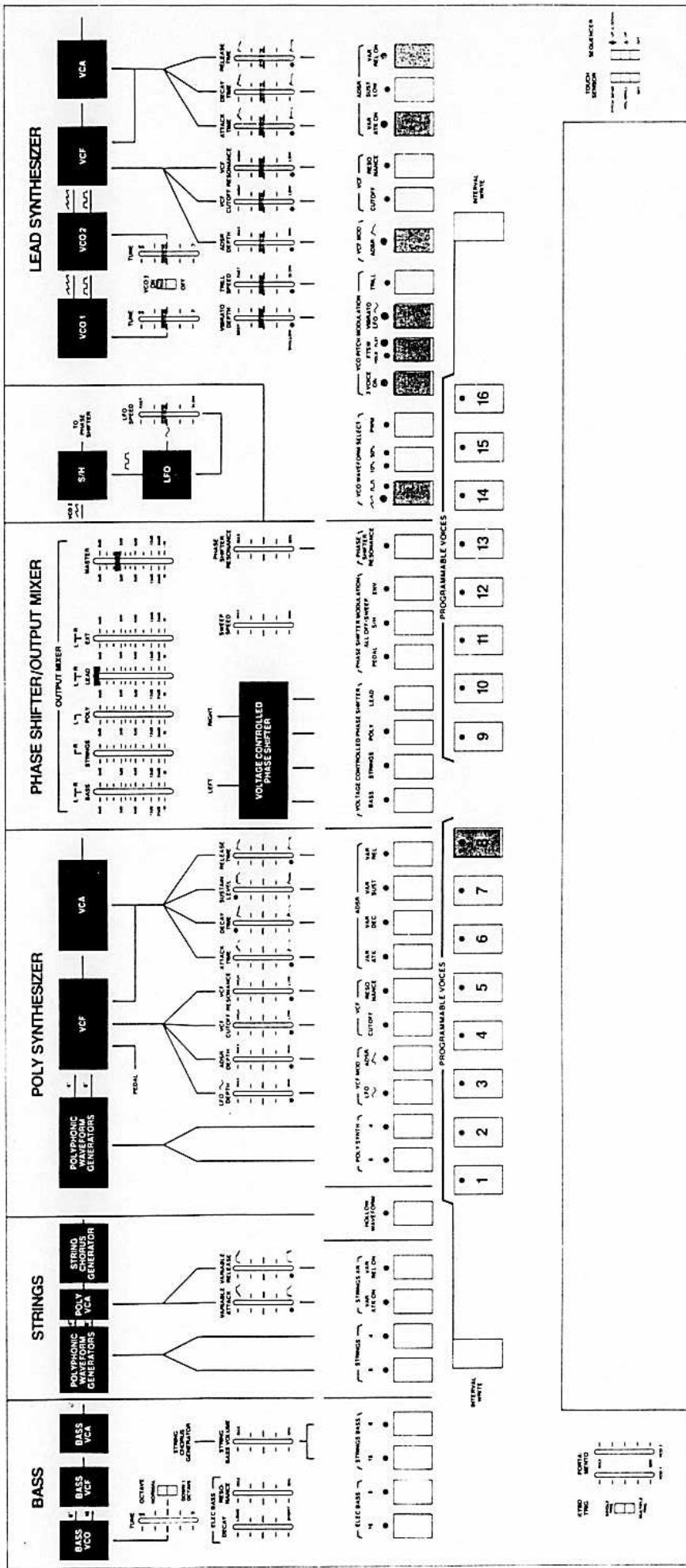

FIGURE E



The switch next to the 10% - 50% switch is marked PWM and, when depressed, allows the envelope settings to modulate the pulse width. All of this creates an exciting, dynamic musical effect.

1. Set up the face panel settings as shown in Figure F.
2. Play a key on the keyboard and listen to the "dynamic waveform" generated. This creates a saxophone-like timbre.
3. Switch to a 10% pulse and notice the difference. What you are hearing is the envelope signal "opening" and "closing" the pulse width from 10% to about 80%. When you use the 50% pulse wave, the envelope will open and close it from 50% to about 80% as well.

2 VOICE ON

You may have noticed that in all of these LEAD experiments only one note can be produced by the keyboard at a time, no matter how many keys are held down. To get two-key capability, turn the VCO 2 ON/OFF switch to the ON position and press the switch marked 2 VOICE ON which is located under the VCO PITCH MODULATION brackets.

Now tap the TWO VOICE ON switch so that the LED goes out. Play several keys at once, and notice that both VCO 1 and VCO 2 will track the highest note played. This can be very effective when used in conjunction with other sections of the Quadra. Try detuning the VCOs slightly with respect to one another.

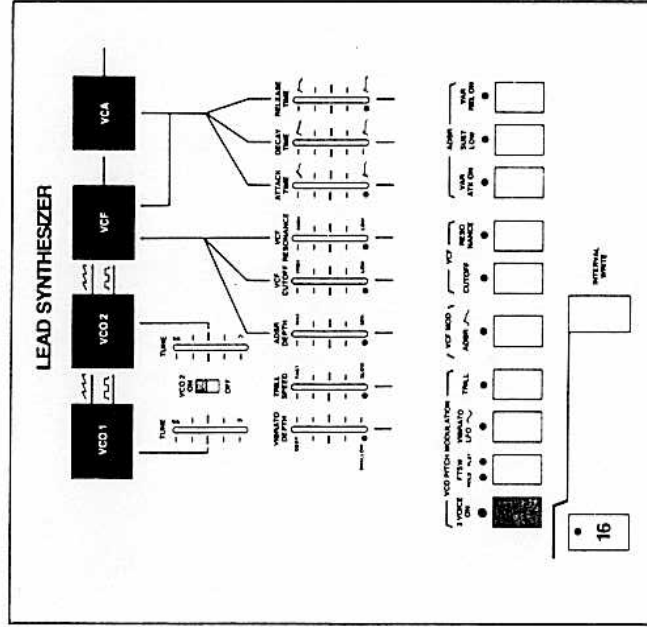

At this time, you may notice that when you depress any two keys, you will hear a two-note interval. If, when you depress one key, you hear two notes, it is because the two oscillators are not tuned to unison. To tune them, simply hold down a key, and move the TUNE sliders until both are in unison.

FIGURE F

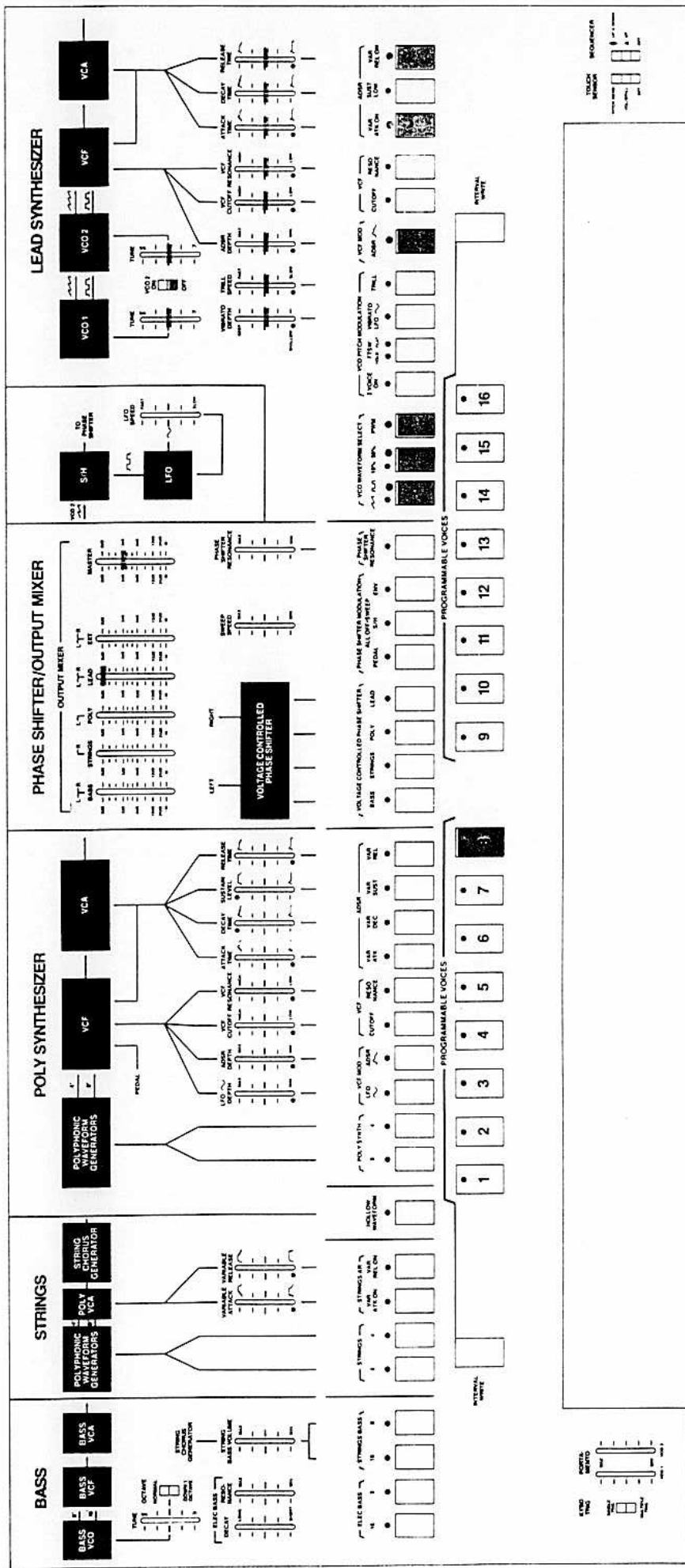

HOLD/FLAT FOOTSWITCH

The HOLD/FLAT select switch (located next to 2 VOICE ON) is used in conjunction with a footswitch. Plug your footswitch into the jack marked FOOTSWITCHES-HOLD/FLAT. You may use this footswitch for three functions:

1. Can keep the GATE ON after a key is depressed, thereby locking the lead pitch on the keyboard.
2. Can lock the GATE OFF if depressed before any keys are depressed.
3. Can be used to duplicate "lip slur" technique which is commonly used by horn or woodwind musicians.

To experiment with this, set up the patch as shown in Figure G and tap the HOLD LED ON. Play a key chord on the keyboard, then depress footswitch shortly after key depression and while keys are being depressed. Keep the footswitch down and release the keys. Notice how the Lead voice sustains. You could, for example, keep this sustaining sound and simultaneously play the STRINGS.

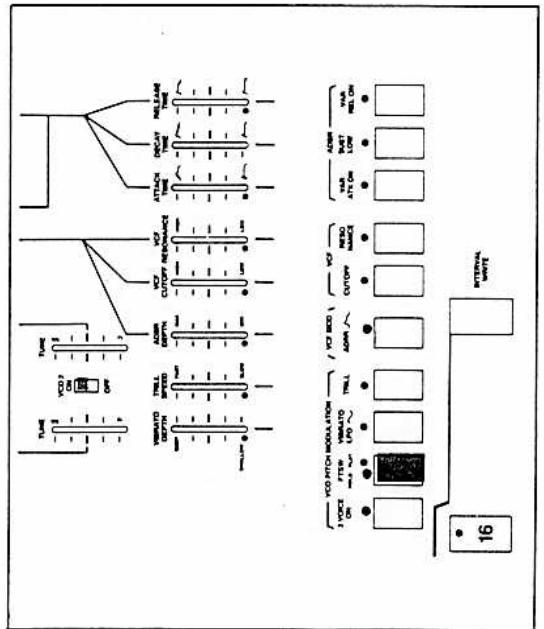

Release the footswitch and, before playing any keys, depress the footswitch and hold it down. Now play the keyboard. Notice that the LEAD is "locked out" (GATE is held down as long as you depress footswitch). While you are playing, release the footswitch and immediately the LEAD comes in. This same concept of bringing in voices is used by traditional orchestras.

The FLAT mode of this footswitch will allow you to lower the tuning of both VCOs approximately 1/2 tone (one semitone) and should be used very discriminately.

Change the HOLD/FLAT switch to FLAT mode, and play a three or four-note tight chord. Depress the footswitch and listen to the pitch change. Try playing a chordal passage, being careful to only depress the footswitch momentarily at the beginning of each chord change. Once mastered, this is an effective way of reinforcing the "layering" effect.

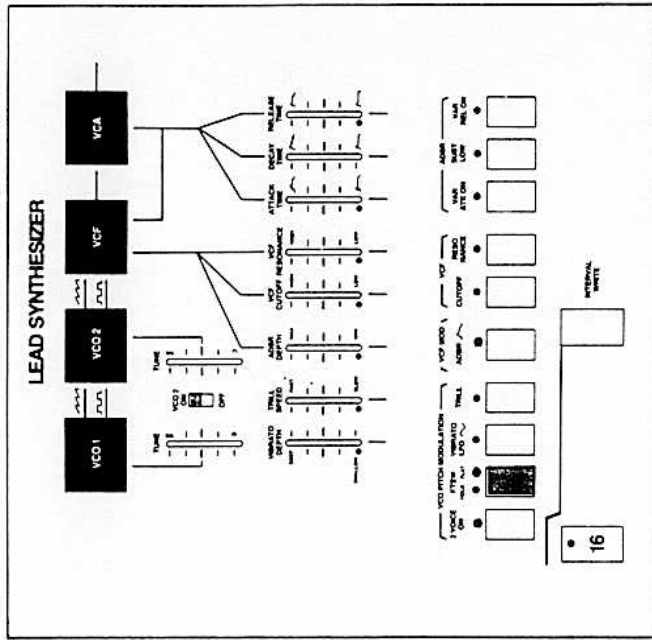

FIGURE G

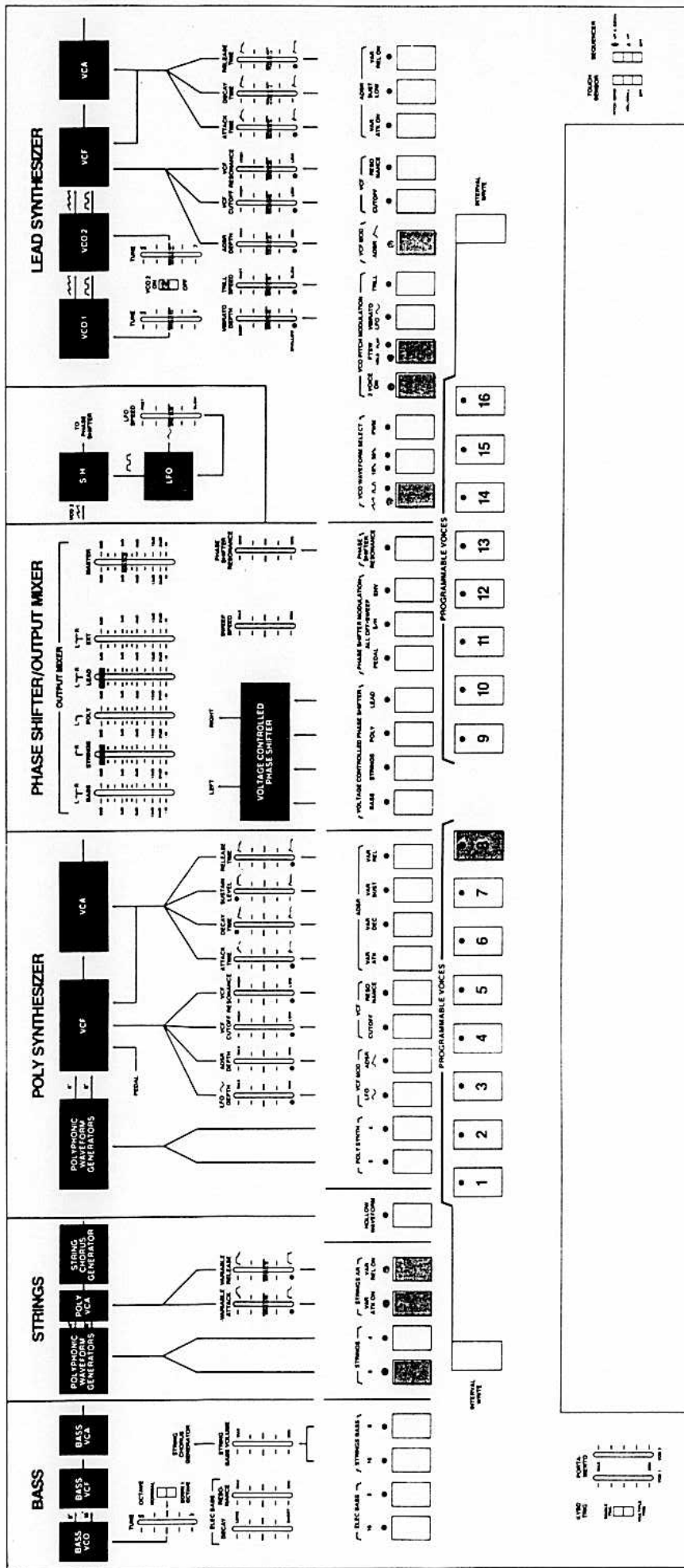
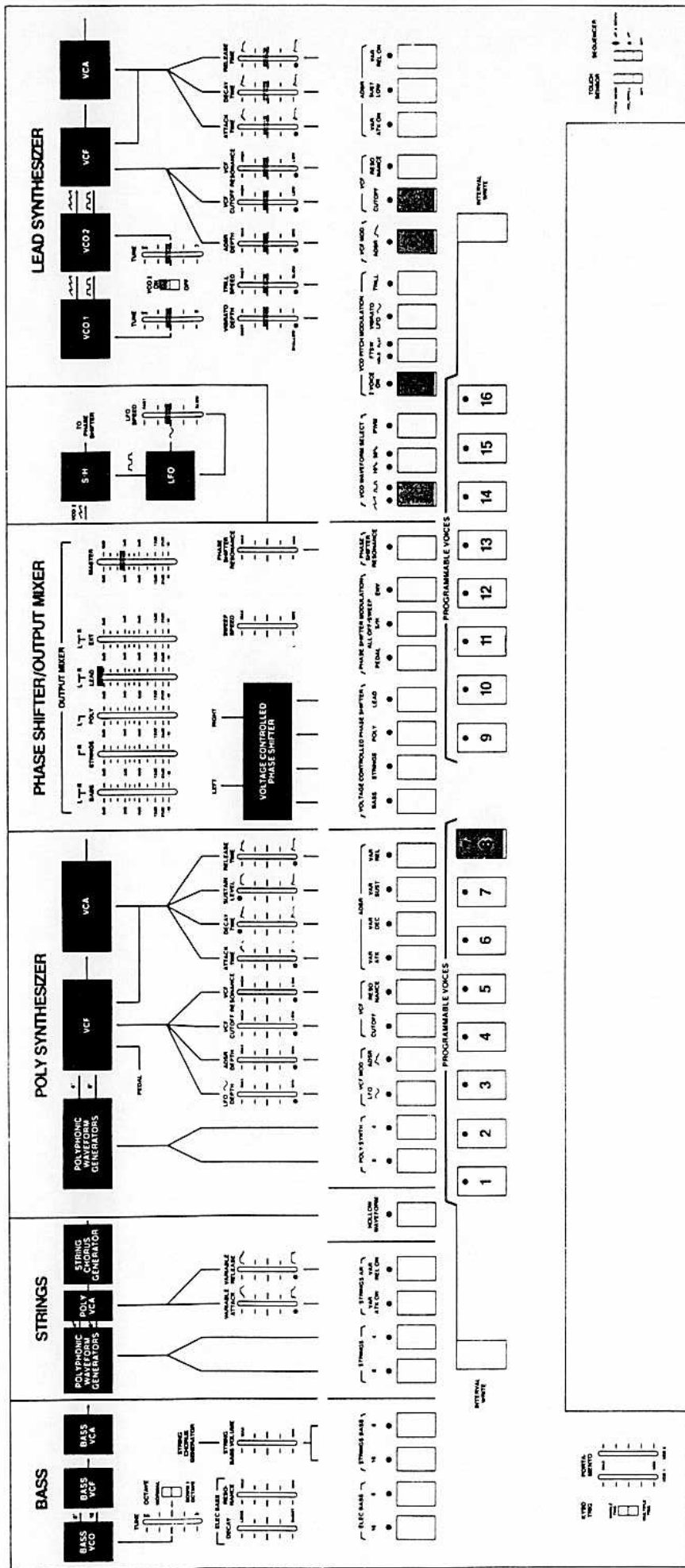

FIGURE H



INTERVAL WRITE

The INTERVAL WRITE feature is one of the most beneficial live performance tools on the Quadra. Interval writing is a fairly new concept that deals with the problems of live-performance tuning of different intervals and pitch relationships between the two VCOs. It allows you to store in the computer's memory any interval or transposition you express on the keyboard. Let's experiment with this.

Set up the face panel as described in Figure H. First let's try loading in different pitch transpositions of the two VCOs.

1. Tap either of the two INTERVAL WRITE switches and notice the 2 VOICE ON LED flashing, indicating that the computer is ready and waiting.
2. To transpose the VCOs to their lowest possible pitch range, depress C1 once on the keyboard. Now play the keyboard and notice how the VCOs have been transposed down.
3. Take your hands off the keyboard and tap the INTERVAL WRITE switch again.
4. Now depress key C2 once. Play the keyboard again and notice that both VCOs have been transposed up one octave.

Therefore, using the INTERVAL WRITE feature for basic transpositions will allow you to control the VCOs over a 10-octave range.

Let's suppose that you want to achieve the effect of two-pitched "tracking" in a parallel interval across the keyboard. This means that when you hit one key you will hear two pitches, giving you a very characteristic synthesizer effect. To do this:

1. Use face panel settings as shown in Figure H.
2. Tap INTERVAL WRITE and wait for 2 VOICE ON LED to flash.
3. Depress C1 first and while you are holding it down, depress C2. The first key depressed is assigned to VCO 1, the second to VCO 2.
4. Now play a musical line on the keyboard (single notes only), and notice that the VCOs play in octaves.
5. Try this same loading format with other intervals in order to get familiar with the technique.

Not only can you load and memorize any interval, but you can also transpose those intervals as well.

1. Again using Figure H settings, tap INTERVAL WRITE and wait for 2 VOICE ON LED to flash.
2. Now depress C2 first and, while holding it, depress C3, for example.
3. Notice how the octave interval is retained but is now transposed up one octave.

Incidentally, in the preceding example, the 2 VOICE ON switch should be turned off. If you leave it on after tuning an interval of one octave, you will hear an interval of two octaves when you depress C1 and C2, for example. This is because VCO 2 is assigned to play the highest note depressed when 2 VOICE ON is in effect, as well as playing an octave interval. Therefore, the memorized octave interval loaded in the computer, added to the octave interval you are playing, gives you a two-octave interval.

One more fantastic feat obtainable using the INTERVAL WRITE circuitry allows you to invert intervals played on the keyboard. Try this:

1. Again using settings shown in Figure H, tap 2 VOICE ON LED so that it is lit.
2. Tap INTERVAL WRITE switch and wait for the flashing LED.
3. Depress C2 first and, while holding it down, depress C1.
4. Now play a major 3rd interval (C3 & E3, for example).
5. Notice that even though you are playing a 3rd, you are actually hearing a 6th.

This happens because in the aforementioned experiment, you just transposed VCO 2 one octave down from VCO 1. Then when you played a 3rd, VCO 2, which is assigned to the highest note depressed, did go up a third in relation to VCO 1, but was already down one octave from VCO 1, the final result being a 6th.

Experiment with other transpositions and intervals until you are thoroughly familiar with this procedure.

VCF RESONANCE

The VCF in the LEAD, although similar to the one in the POLY, is controlled differently with respect to the keyboard. You may have noticed when playing the POLY that as you play higher on the keyboard, the sound gets brighter. This phenomenon is called "VCF tracking with the keyboard." The POLY VCF is calibrated to respond to open 1 octave for every positive two volts applied to it (2V/oct.), but the LEAD VCF responds to open 1 octave for every positive one volt applied to it (1V/oct.).

This means that you can use the VCF in high resonance as a tunable keyboard-controlled swept resonator. Try this experiment:

1. Set up panel as shown in Figure 1.
2. Hit INTERVAL WRITE and depress C2 once.
3. Now, by adjusting the slider marked VCF CUTOFF, try to tune the VCF to a unison with the two oscillators. Be careful not to use too much resonance as this will create feedback.

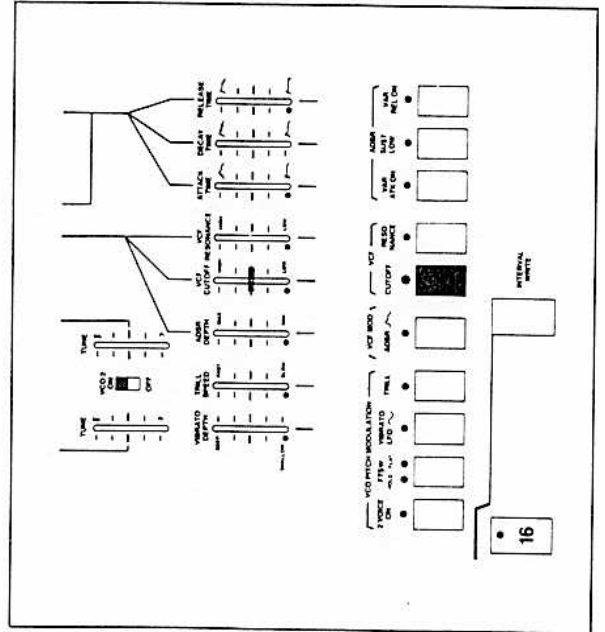

ENVELOPE GENERATOR

The LEAD section contains an extraordinary envelope generator capable of producing a very complex envelope. Technically, it would be called an ADSASR. The ADSASR (Attack-Decay-Sustain-Attack-Sustain-Release) works in the following manner:

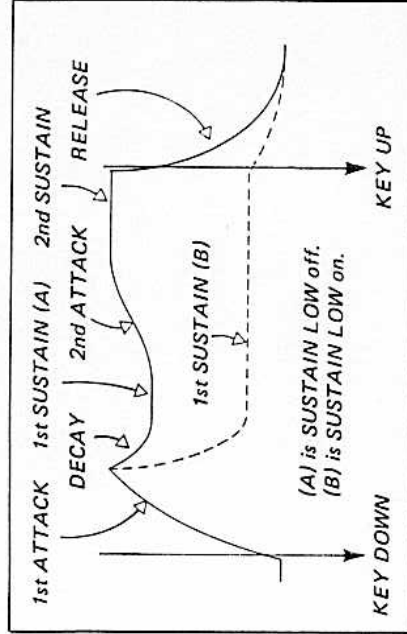

When a key is depressed, the Quadra generates an ATTACK signal which can be either preset or variable. At this point, it is important whether the SUS LOW switch is on or off. If the SUS LOW switch is on, then the DECAY TIME slider may be used to set the length of decay, and there is no preset value. The signal will then decay to about 20% of peak, where it will remain until the key is released.

If, however, the SUS LOW switch is off, the decay signal becomes preset, and the DECAY TIME slider may be used to set the sustain level anywhere from zero to about 75% of peak. The signal will remain at this level briefly, then begin a second ATTACK, which is preset. Eventually, the second ATTACK reaches 100%, and remains there until the key is released. Upon release of the key, the RELEASE function takes over. Once again, this function is either preset or variable.

4. Play from the lower end of the keyboard to the top of the keyboard and listen to the VCF track with the VCOs.
5. Try to tune the VCF CUTOFF to other intervals and again notice how the VCF can be used to dramatically change the timbre and character of a sound.

FIGURE 1

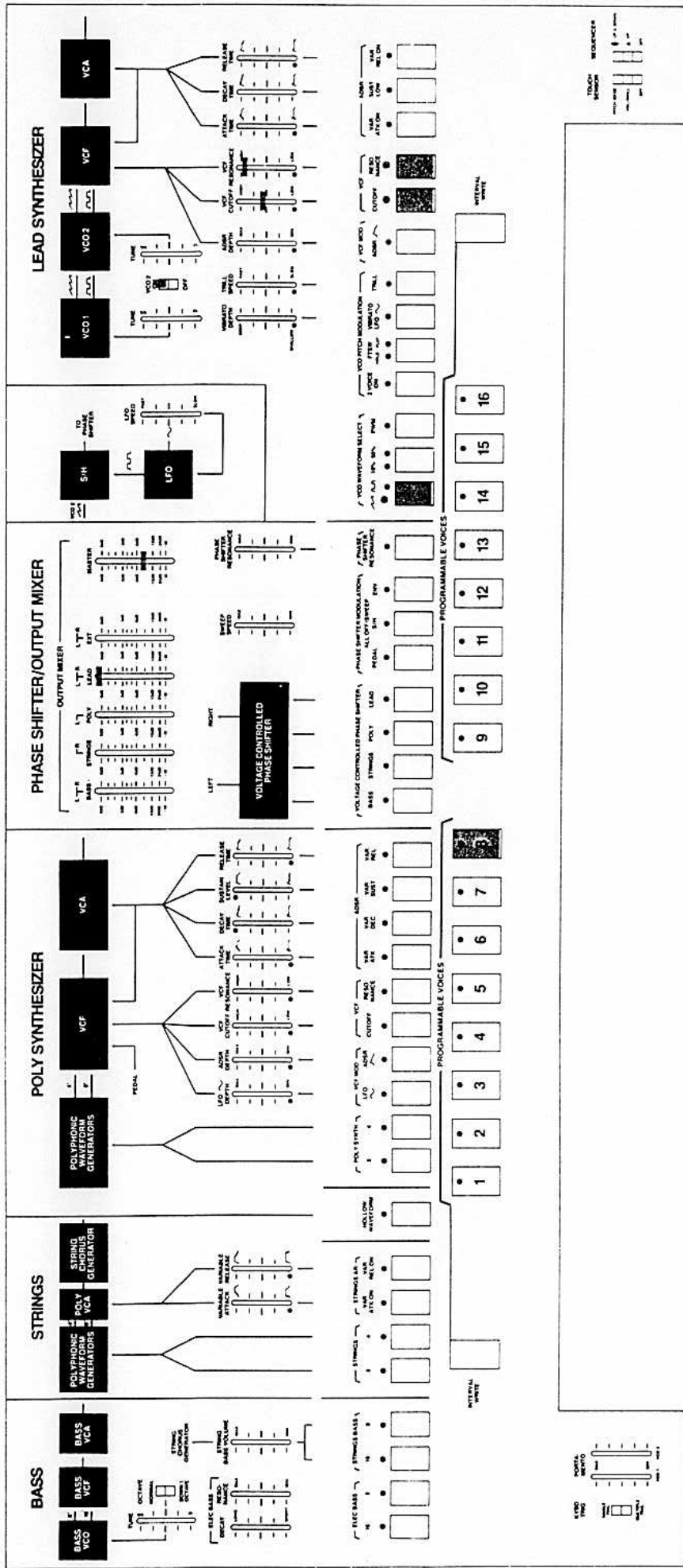

Notice the slider marked **DECAY TIME**. This slider does not have a factory preset (orange dot) because this is the only slider in the variable choice row that is active all the time and, consequently, is not dependent upon whether the LED below it is On or Off. This may sound a bit contradictory to the slider/switch philosophy, so let's experiment to clarify its function.

1. Set up face panel as shown in Figure H.
2. Tap the switch marked **SUS LOW** so that its LED lights. Place the slider above it at the midway point. Turn off the **CUTOFF** switch.

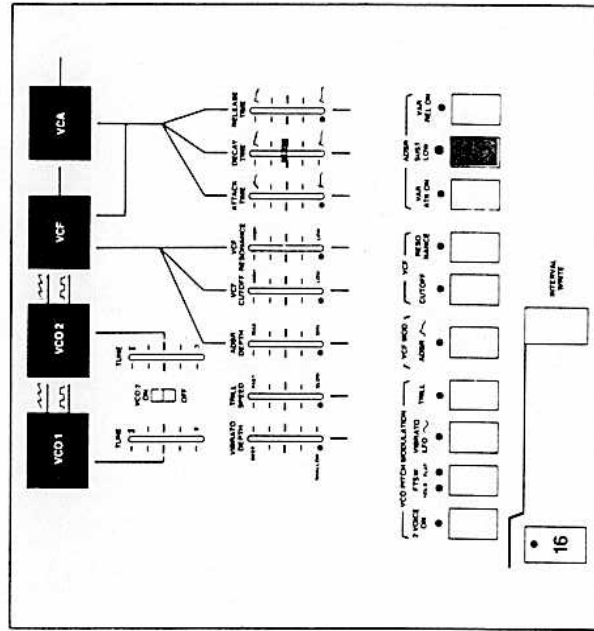

3. Play a few notes on the keyboard and notice the plucked articulation generated. This is happening because **ATK** and **RELEASE** LEDs are off, putting them at their factory preset fast **ATK** and short release positions.
4. Also notice that the sustain is very low, and decay is relatively fast.

5. Move the **DECAY TIME** slider to the top of its travel and play the keyboard. Notice how the decay is much slower now, but if the key is held down, the tone will still die down to the low sustain level. Therefore, when the **SUS LOW** LED is on, the slider above it simply becomes a decay time control.

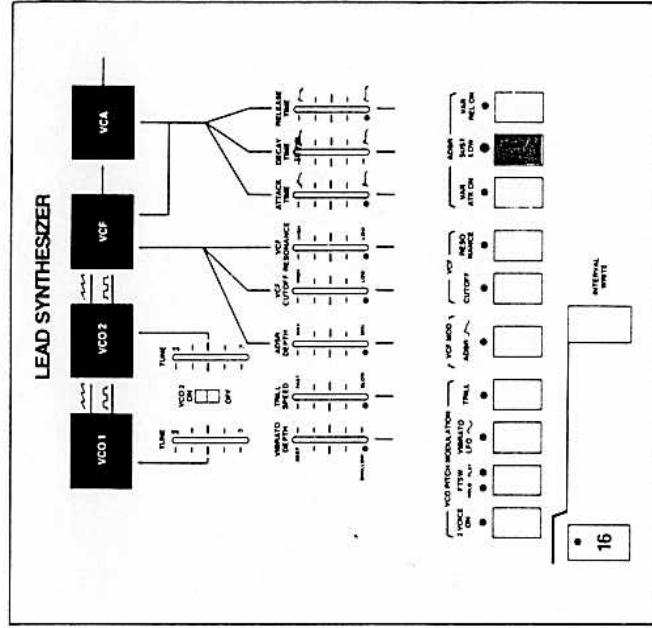

6. Now tap the **SUS LOW** switch again (**LED off**), and position the **DECAY TIME** slider at its midway position.
7. Press a key and, while holding it down, listen to the effect of the second attack. In musical language this is known as a **sforzando (sf)** and is quite useful in the creation of punchy brass or orchestral effects.

8. Move the **DECAY TIME** slider to its top position, and depress a key. Notice that the second attack is barely heard. This is because by moving the slider up you also moved the sustain level to its maximum, about 75%. This means that the decay function did not have very far to decay to, and the second attack did not have very far to go as well. See Figure J.

FIGURE J

SUS LOW off, DECAY TIME slider high.

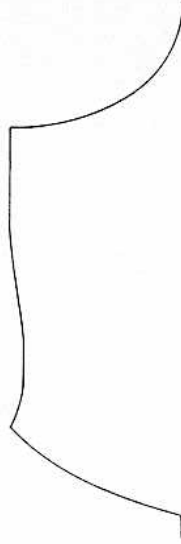

SUS LOW off, DECAY TIME slider low.

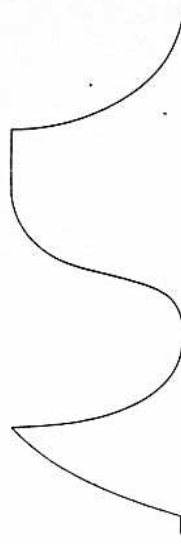

Therefore, when the **SUS LOW** LED is off, and the **DECAY TIME** slider is in the middle or lower portion of its travel, the full **ADSASR** envelope will be produced.

FIGURE K

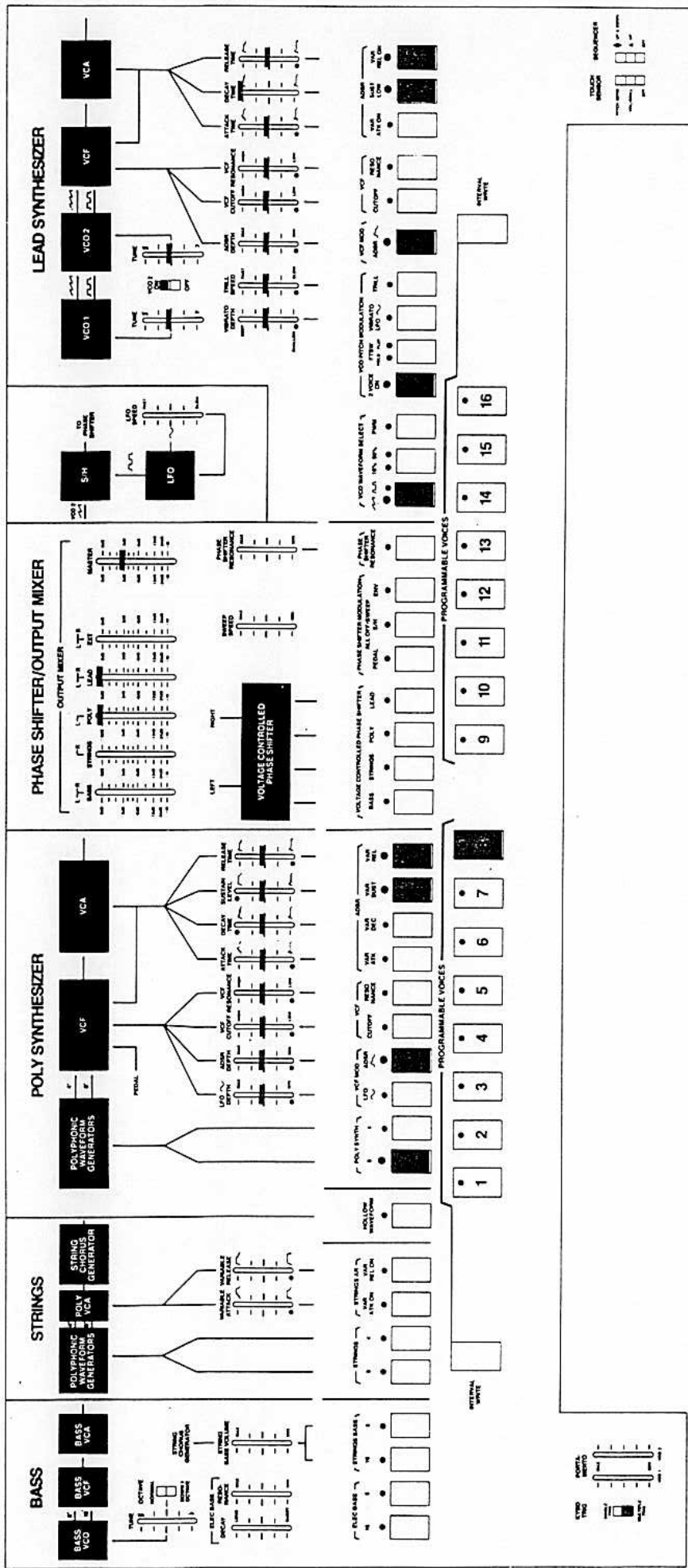

PORTAMENTO

Portamento, the characteristic sliding sound heard between keyboard intervals, is available in a unique form on the Quadra. The PORTAMENTO speed sliders are located near the left end of the keyboard. The unique part of the PORTAMENTO circuit is the ability to assign varying discrete portamento speeds to each VCO in the LEAD Section of the Quadra. PORTAMENTO only works on the LEAD VCOs. To experiment with this:

1. Set up any patch on the Quadra, listening only to the LEAD in its TWO-VOICE mode.
2. Plug your footswitch into the jack on the rear of the Quadra marked FOOTSWITCHES-PORTAMENTO.

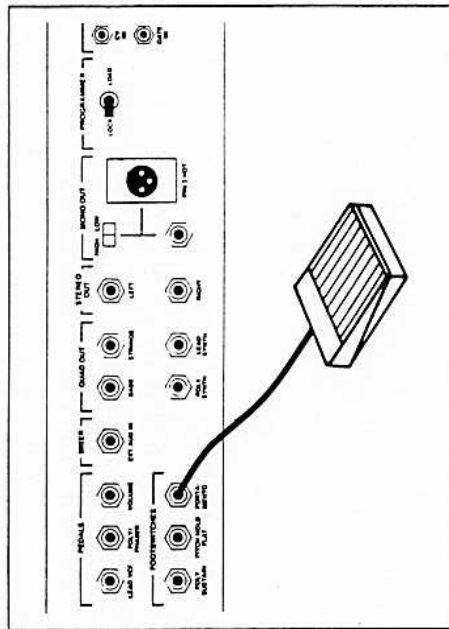

KYBD TRIG

This switch controls a special circuit that can dramatically alter the way the keyboard responds to your playing technique. The circuit controls the triggering mode of the POLY SYNTH envelope generator, the LEAD envelope generator, and the LEAD envelope generator triggering by the SEQUENCER. Set up the panel as shown in Figure K.

1. Place the KYBD TRIG switch in the MULTIPLE position and play chords with your left hand and a lead melody with your right hand. Notice that whenever you play a new key, a new trigger is generated, firing the envelope generators. This feature is used when you want to play fluid lines quickly and will help you avoid missing notes.

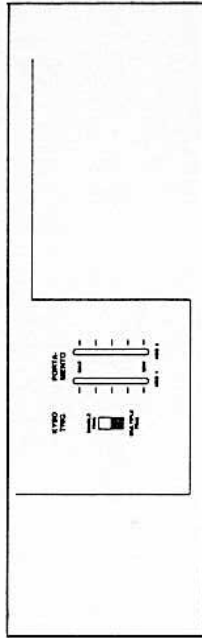

2. Now move the switch to the single position and play the same way as you did earlier. If you can play very legato; i.e., move from key to key without lifting fingers, you can prevent additional triggers from being generated. This makes it possible to accent notes or use phrasing techniques in your playing.

3. Raise the VCO 1 PORTAMENTO slider to MAX, depress the footswitch and play the keyboard. Listen to the unique combination of sliding/fixd pitches produced by having VCO 1 with portamento and VCO 2 without.

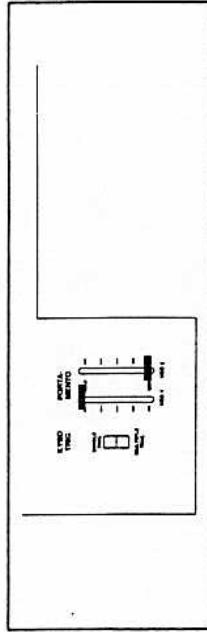

4. Experiment with different slider combinations of portamento. The footswitch serves only to turn the portamento ON or OFF externally. If you unplug this footswitch, the only way to turn off the portamento effect is by lowering both PORTAMENTO speed sliders.

FIGURE L

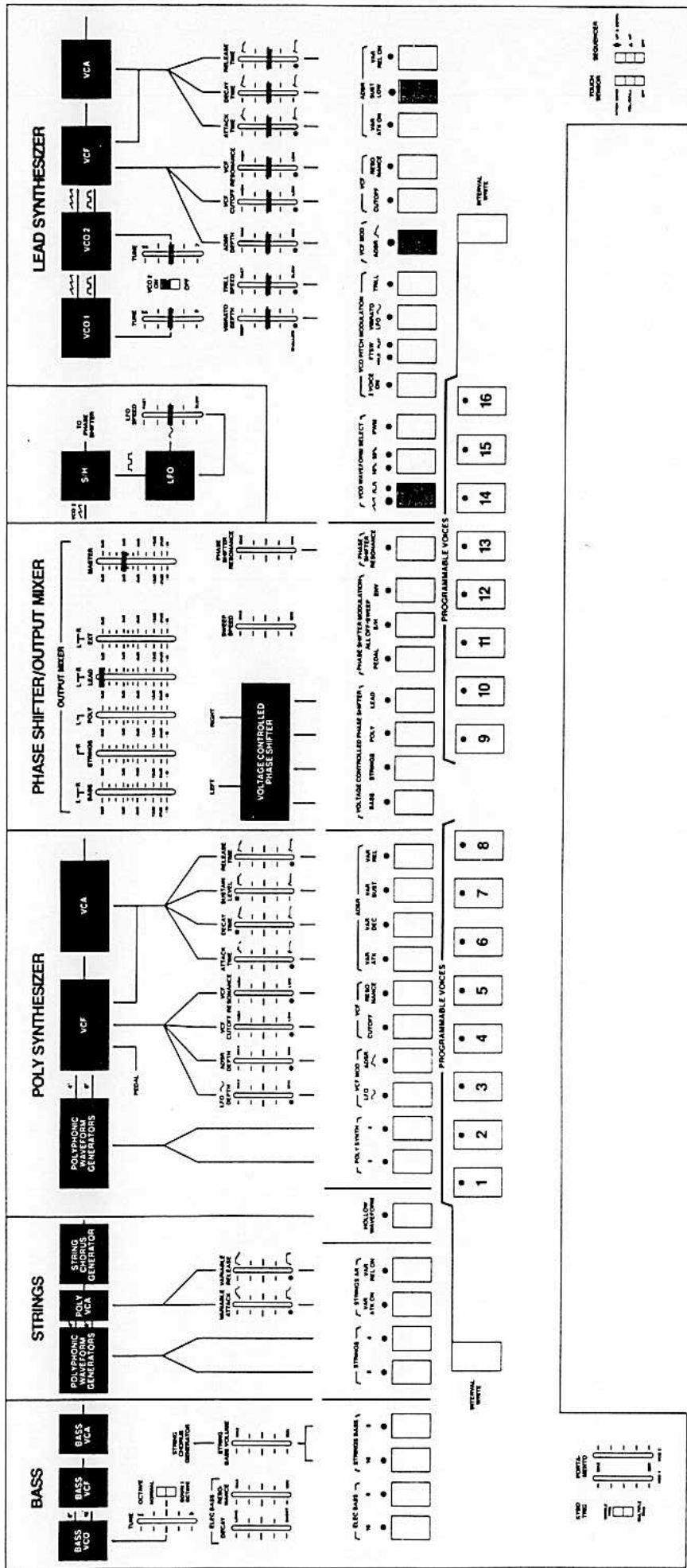

TOUCH SENSOR

The TOUCH SENSOR works on the top three octaves of the keyboard and applies its effects directly to the LEAD section only. The TOUCH SENSOR switch is located near the right side of the keyboard and offers you a choice of PITCH BEND (up), and a combined VOL/BRILL function, which causes the sound to get both louder and brighter. To use this feature:

1. Set up the LEAD section so that the envelope is controlling the VCF. Set the TOUCH SENSOR switch to the PITCH BEND position.

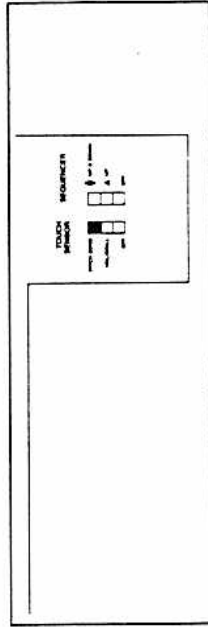

2. Play any key on the top three octaves and depress the key further down till resistance is felt. At this point you will start to hear the pitch start to rise. This is a graduated TOUCH SENSOR so that the harder you press, the more effect will be produced.

The pitch bend is calibrated to a maximum deviation of approximately a perfect fourth sharp. You can imitate traditional rock and roll guitar string bending techniques, or brass shakes, by manipulating the pitch via the TOUCH SENSOR.

SEQUENCER

The SEQUENCER is another very important live performance tool contained in the Quadra, and it also augments the layering effect common to the instrument.

When a chord is depressed, the integral computer scans the keyboard and, when the SEQUENCER is turned on, an arpeggio is created using the keys that have been depressed. The sequence is not limited to a given amount of notes. In other words an arpeggio will be generated using any number of keys depressed.

Let's experiment:

1. Set up the panel as indicated in Figure L. Tap INTERVAL WRITE and play C3 on the keyboard.
2. Move SINGLE/MULT trigger switch to MULTIPLE position and move the SEQUENCER switch to UP marking.

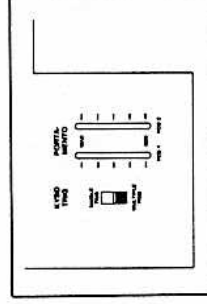

3. Play a three-note chord and notice how an upward arpeggio is generated. The TRILL SPEED slider will govern the speed of the SEQUENCER.

- Now move the SEQUENCER switch to the UP AND DOWN marking. Play a chord and notice how the arpeggio rises and falls.

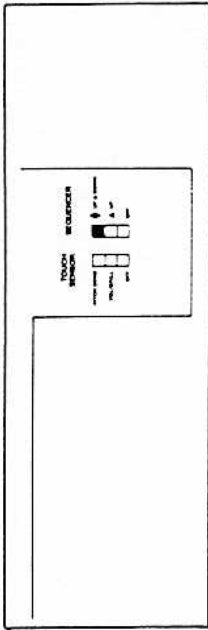

As stated earlier, the SINGLE/MULT switch will change the way the SEQUENCER TRILL-LFO articulates the LEAD envelope generator. Actually, when the SEQUENCER is turned ON, the SEQUENCER LFO generates gates and triggers in sync with the pitch change of the VCOs. Experiment with different positions of the SINGLE/MULT switch as well as with different envelopes.

One of the most usable benefits of this SEQUENCER is the fact that while a LEAD sequence is being generated, the STRINGS, POLY and BASS sections can be brought in, adding to the layering effect. Also, if you plug your footswitch into the FLAT/HOLD jack, you can lock the sequence in by depressing the footswitch, leaving your hands free to play lines on the keyboard. To do this:

- Experiment with different chords on the keyboard in order to generate different sequences.

An interesting and complex variation can be created using the INTERVAL and TRILL WRITE and the SEQUENCER. For example:

- Turn SEQUENCER OFF.
- Use Figure L settings. Tap 2 VOICE ON and TRILL ON.
- Tap INTERVAL WRITE and load in a fifth interval.
- Tap the INTERVAL WRITE again and, as soon as 2 VOICE ON flashes, tap the TRILL switch and depress key C2.
- Turn SEQUENCER on (UP AND DOWN) and play the keys starting from the bottom up: C, F, G, B, C, F, G, B, C. Depress HOLD footswitch to lock in sequence.

Now you should hear the sound of the two VCOs tuned to a fifth, trilling an octave, and arpeggiating at the same time. When you combine this sequence with the other Quadra sections, the result can be overwhelming.

Experiment with other variations of this patch until you become thoroughly familiar with the procedure.

- Tap the HOLD/FLAT switch so that the HOLD LED lights.
- Play the desired chord on the keyboard.
- After depressing the keys, depress the footswitch while keys are down and keep the footswitch down.
- Now you can remove your hands from the keyboard and the sequence will keep going until you release the footswitch.

PHASE SHIFTER/OUTPUT MIXER

To clarify the function of both the audio and control switches, experiment with the following procedures.

1. Set up face panel as shown in Figure M.
2. Tap the switch marked STRINGS under the VOLTAGE CONTROLLED PHASE SHIFTER brackets.
3. Play a chord and notice the full expansive effect of the strings. The phase shifter's unique stereo animator creates the illusion of the sound physically moving around the room.
4. Move the SWEEP SPEED slider and notice that this slider governs the speed of the pseudo-pan. When all three modulation control LEDs--pedal, S/H, and ENV--are Off, the SWEEP LFO is automatically patched in to control the PHASE SHIFTER.

The PHASE SHIFTER on the Quadra is a unique effects device in itself. It can be used to create a variety of effects including ethereal effects, rhythms and funky sounds, and has the ability to change the four mono audio inputs into spacious stereo animation.

The PHASE SHIFTER has two types of switch controls associated with it; 1) Audio Input Select, and 2) Modulation Select.

Although the Quadra panel graphics show the PHASE SHIFTER/OUTPUT MIXER in the same location, they are in fact two separate circuits and can be used independently.

The OUTPUT MIXER is actually a way to mix the four sections to your own taste. The five sliders indicate audio inputs to the mixer and of course the MASTER represents the OUTPUT. When mixing the various signals, always remember to keep the input sliders as high as possible in relation to the MASTER. This will give you the best signal/noise ratio. In other words, use the MASTER as the volume control, or use the pedal as a volume control. (Plug pedal into jack marked PEDALS--VOLUME.)

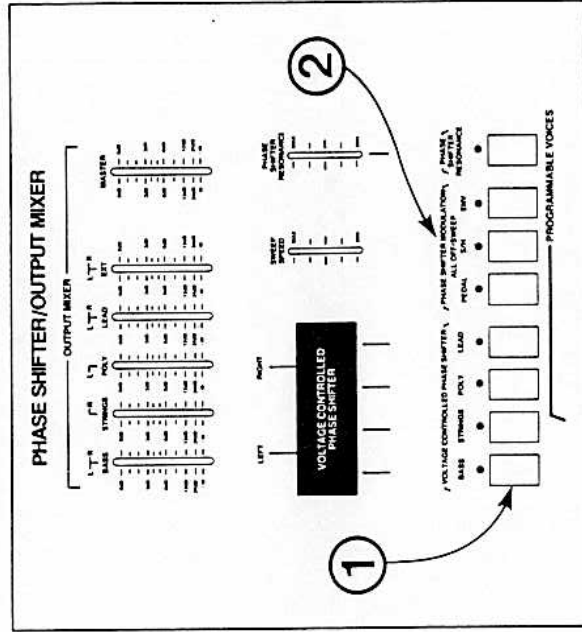

Basically, the Audio Input Select switch allows you to route any or all of the Quadra sections (BASS, POLY, STRINGS, LEAD) into the PHASE SHIFTER for further processing. The MODULATION switches allow you to control the PHASE SHIFTER in a variety of ways. Control can be by pedal, S/H, preset envelope, and LFO in a number of combinations.

Even though the phase shifter effect can be utilized by monitoring the mono output jack on the Quadra rear panel, the most dramatic effect achievable from the PHASE SHIFTER requires that you hook up the Quadra in its "stereo" mode. (Refer to Page 37, rear panel jack explanation.)

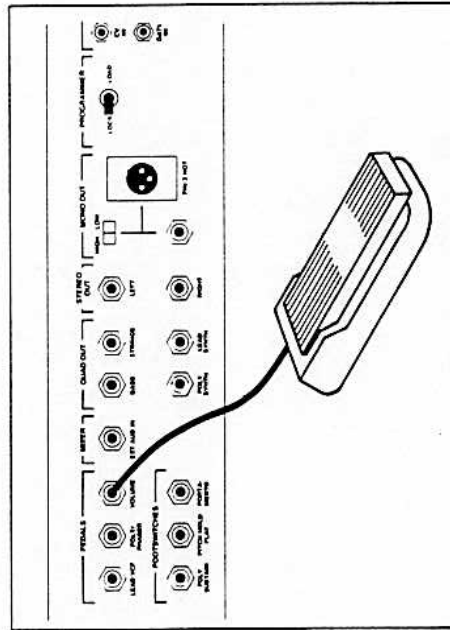

Located above the OUTPUT MIXER input sliders are graphics indicating the audio routing of the signal when the rear panel stereo jacks are used. In the mono mode, however, all of these audio input sliders are mixed down to one channel.

The EXTERNAL slider is an auxiliary audio input and can be used when interfacing another synthesizer with the Quadra so that its volume is controllable on the Quadra's face panel.

FIGURE M.

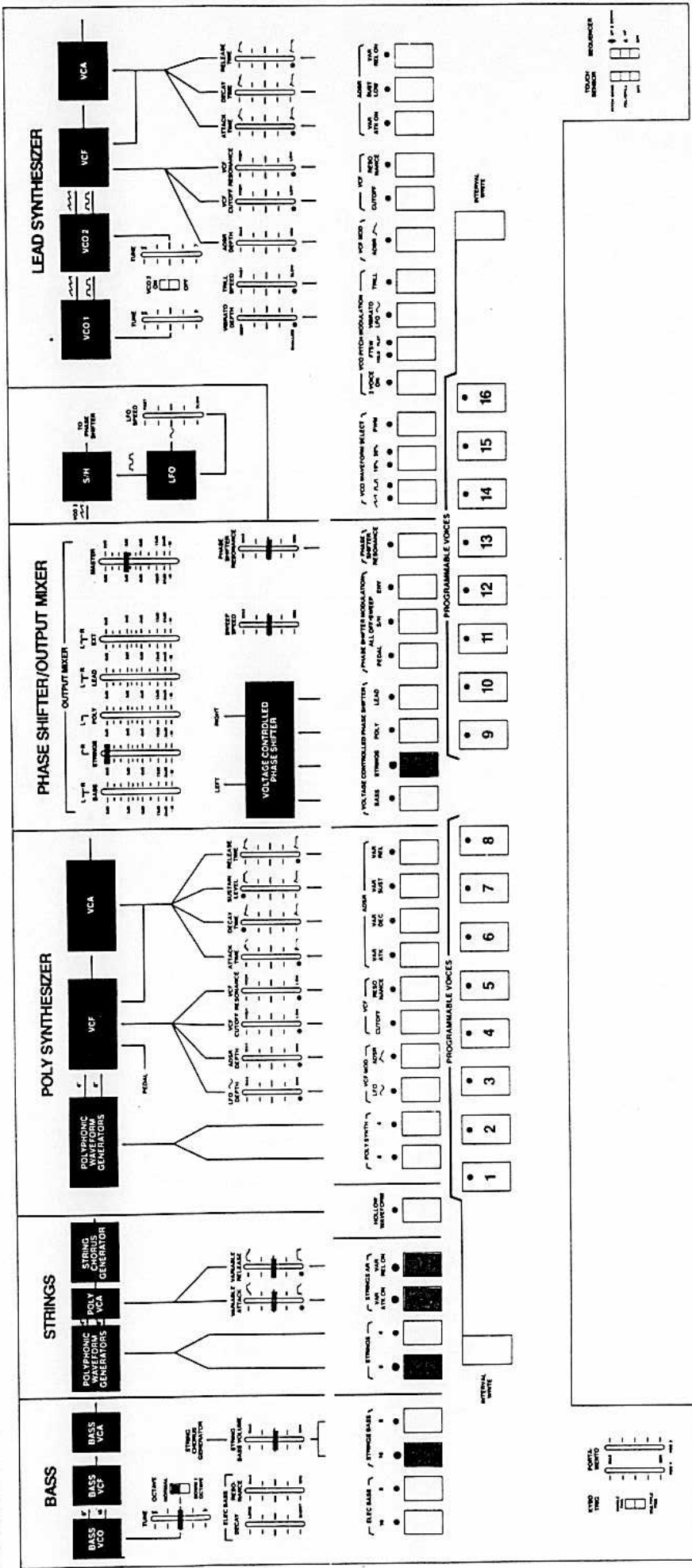

PHASE SHIFTER MOD

Phase Shifter Resonance serves to accent the harmonics of the phase shifter similar to the way it works with a standard VCF.

1. Tap **RESONANCE** switch ON and, using the aforementioned patch, play a chord on the keyboard. Notice how the classic sound of the strings is changed into an ethereal spatial effect. This effect is especially dramatic when the sweep speed is lowered to its slowest rate.
2. Move the **RESONANCE** slider up to maximum and notice how the harmonics are accented even stronger still.

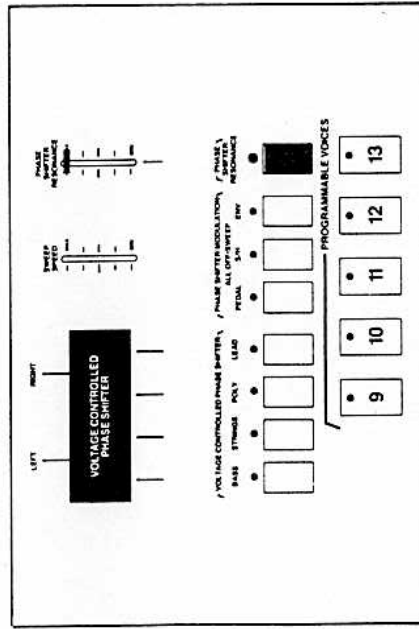

3. Now, using this same patch, tap the **PEDAL MODULATION** switch ON. (Plug pedal into rear panel jack marked **PEDALS--POLY/PHASER**.)
4. Hold down a chord on the keyboard and slowly move pedal up and down. You are now manually sweeping the phase shifter and, if desired, can lock the phaser in any position simply by keeping the pedal in a static position. This effect can be either ethereal or funky sounding depending on the patch and keyboard technique used.

5. Now tap the **PEDAL** switch out and tap the **S/H** switch ON. **S/H**, when applied to a conventional VCO is, of course, responsible for the characteristic "random computer language" sound used so extensively in the creation of sound effects. However, when applied to the **PHASE SHIFTER**, a unique funky-rhythmical sound is produced.

6. Play a chord using the **S/H** and listen to the effect. Speed of the **S/H** effect is determined by the **LFO SPEED** slider.

The **S/H** is prepatched to scan the frequencies of the VCO 2 audio sawtooth wave. This means that whenever you play a different key in the **LEAD** Section a new **S/H** sequence will be produced. Try playing a chord with your left hand and then play a slow chromatic scale with your right. Listen to the varied sequences produced.

The **ENVELOPE** switch allows you to control the sweep of the **PHASE SHIFTER** with its own preset **AD** (attack, decay) envelope generator. This will create a very funky effect. The **AD** envelope generator is always in a single trigger mode, but can be triggered in a variety of ways. For example:

1. If any of the **STRINGS**, **POLY SYNTH**, or **LEAD** LEDs in the **PHASE SHIFTER** input section are lit, and the **BASS** LED is not lit, you can trigger the envelope over the full range of the keyboard.
2. If any of the **STRINGS**, **POLY SYNTH**, or **LEAD** LEDs in the **PHASE SHIFTER** input section are lit, and the **BASS** LED is also lit, then you can NOT trigger the envelope unless you depress a key in the 2 octave **BASS** range.

Experiment with No. 2 and notice that if you only play keys above the keyboard split, the **PHASE SHIFTER** will remain locked until you depress any key below the keyboard split (**B2**).

With the exception of the **LFO** sweep, all of the **PHASE SHIFTER** controllers, (**PEDAL**, **S/H**, **ENV**) can be combined. Experiment with different combinations and see how many new effects you can create.

REAR PANEL JACKS

The rear panel jacks allow you a variety of audio and interface hookups and are similar to the interface jacks on other ARP products.

Naturally you will want to hook up your Quadra the way you like it best. However, if you prefer a simple yet effective utilization of these output jacks, hook it up as described below.

Requirements

1. One high quality, full range P.A. system.
2. Any type of good quality Bass Amp.

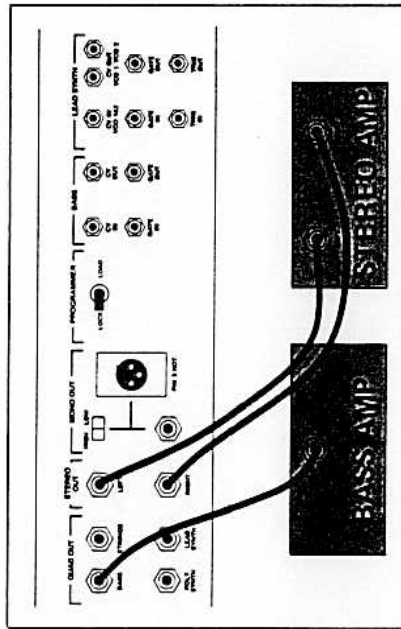

As stated earlier, if you do not have access to a stereo sound system, you can still obtain a good sound from the Quadra by using the MONO OUT jacks, as described in the section discussing INITIAL HOOKUP on Page 2.

The XLR output can provide a "hum free" signal when used in conjunction with a mixer that features "balanced line" inputs.

Here's how to wire up your own cables.

1. Obtain one "female" XLR connector and one "male" connector.
2. Obtain the desired length of "2-conductor shielded cable" (15' is usually standard).
3. Wire the connector as follows:

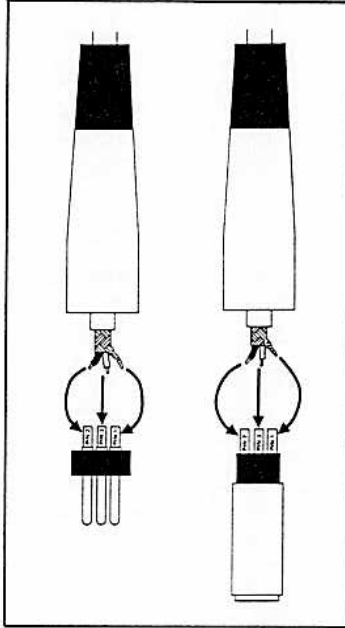

4. Pin 3 is "hot," and is connected to Pin 3 on the other connector.
5. Pin 2 is connected to Pin 2.
6. Pin 1 should be connected to the cable shield on both the "male" and "female" sides.

Study the rear panel breakout chart on the next page to clarify the purpose of the remaining jacks.

Notes:

1. QUAD OUT jacks disconnect the signal from the main output and phase shifter mix whenever a jack is inserted.
2. BASS CV and GATE OUTPUT jacks are operable only when any of the front panel BASS SELECT LEDs are lit.
3. LEAD CV, GATE and TRIG RANGE is C1 to C6 except when any BASS voice is selected, then the range becomes C3 to C6.
4. A unique feature is built into the QUAD OUT jacks allowing you to process the individual sections from the Quadra, and bring them back into the PHASE SHIFTER/OUTPUT MIXER.

Observe the following diagram for an example of this great effect.

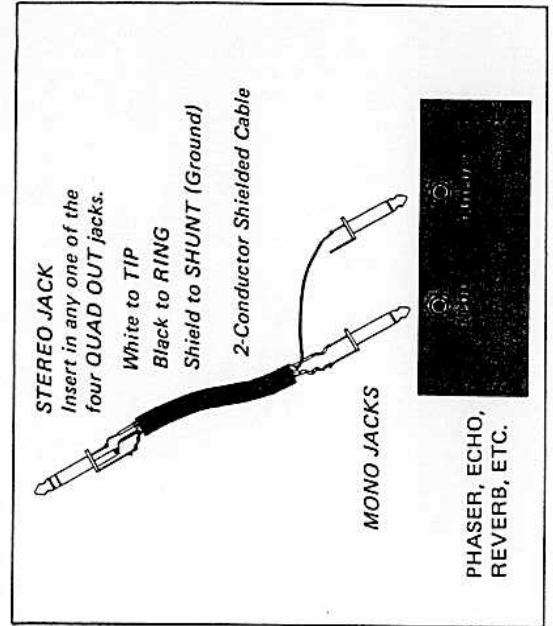

ARPQUADRA

ARP INSTRUMENTS, INC. - LEXINGTON, MASS.



EXTERNAL AUDIO IN-
Allows you to control the volume of an audio signal from an external source on the front of the Quadra (Mixer section).

MONO OUT-
Both 1/4" and XLR jacks are switchable from high to low level signal.

QUAD OUT-
Allows you to process or amplify any signal from the Quadra independently of the others.

LEAD CV IN, GATE IN, and TRIG IN-
Allows control of LEAD section by a sequencer or other keyboard.

LEAD CV OUT, GATE OUT, and TRIG OUT-
Allows LEAD section to control other synthesizers. Separate CVs for both VCOs are available.

PEDAL and FOOTSWITCH jacks-
Permit expressive control over different sections of the Quadra.

STEREO OUT-
All sections are mixed down to two outputs (routing is indicated on the front panel).

BASS CV OUT and GATE OUT-
Allows BASS section to control other synthesizers (range: C1 to B2).

BASS CV IN and GATE IN-
Allows control of BASS section by a sequencer or other keyboard (range: C1 to B2).

PROGRAMMER switch-
In LOCK position, this switch protects all 16 programmed voices from erasure. In LOAD position, it allows you to change them at will.

MEMORY LOADING

MEMORY MAINTENANCE

By this time you should have a good idea of how the two types of switches (1-16 voice locations and preset/variable select switches) interrelate.

Actually, loading and locking in your desired program is quite easy if you follow these steps:

1. Locate the small LOAD/LOCK toggle switch on Quadra Rear Panel and switch to LOAD position. THIS ACTION MAKES ALL SIXTEEN VOICES VULNERABLE TO ERASURE.
2. Tap voice location No. 1.
3. Position all sliders at their mid position.
4. Tap in your desired program using the PRESET/VARIABLE select switches. (Remember to load in any VCO Interval, Transposition and Trill Interval.) The program is now loaded into the computer memory.
5. Program voices 2 thru 16 in the same manner and, when finished, move the rear panel toggle switch to the LOCK position. Memory will now be retained as long as that switch is locked.

When you unplug your Quadra your 16 patches will still be retained by a battery back-up power unit located inside the Quadra (3 AA size batteries). Power drain is very minimal and life expectancy of the batteries is approximately 1 year; therefore, yearly maintenance at an authorized service center for tuneup and battery change is recommended.

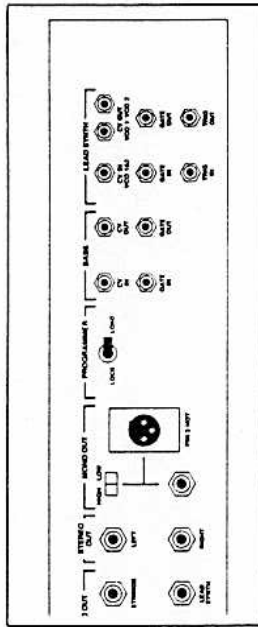

TROUBLESHOOTING

PROBLEM	SOLUTION
No LEDs Lit	Switch on? Check power cord and outlet for good connection.
LEDs Lit/No Sound	Mixer Sliders up? Volume pedal plugged in/Toe down? Audio system hooked up? Program latched into memory?
Can't change voice location 1 through 16 (voice locked)	Is 2 VOICE ON Flashing? (Tap keyboard).
Voices sound incorrect	All sliders at mid position? Check tuning of BASS and LEAD VCOs.
STRINGS and POLY SYNTH are out of tune with another non-tunable keyboard	Locate small trimpot hole on Quadra rear panel. Insert small screwdriver and turn either way for sharp or flat.
SEQUENCER doesn't articulate LEAD Envelope Generator	Switch to MULTIPLE trigger.
LEAD or POLY SYNTH ADSRs have little or no effect on VCFs	Check to see if pedal is plugged into LEAD VCF jack. If toe is down, pedal will keep VCF open. Unplug pedal or depress heel.
TOUCH SENSOR not sensitive enough	Insert tiny screwdriver into small hole located next to TOUCH SENSOR switch. Turn either way for more or less sensitivity.

IMPORTANT! READ THIS FIRST!

1. PERCUSSIVE GLOCKENSPIEL

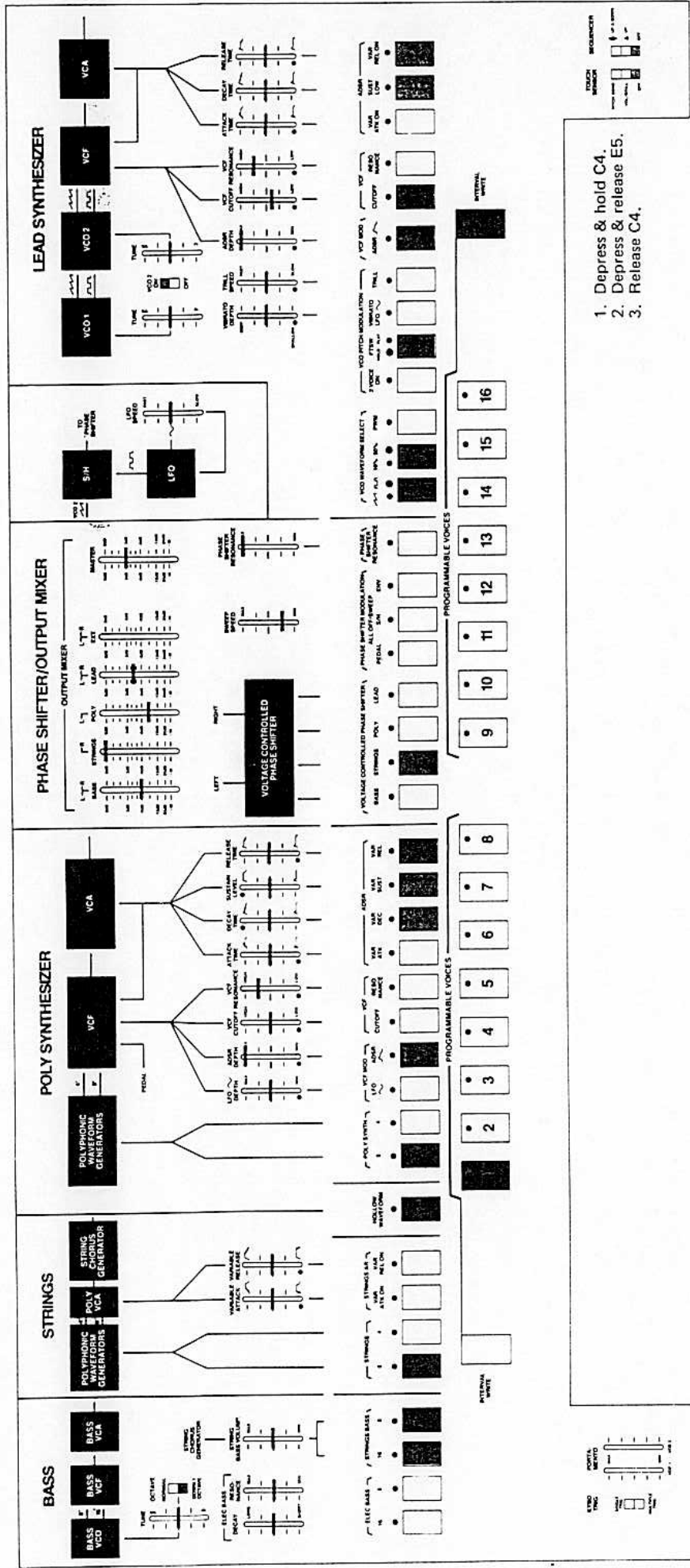

The factory-loaded voices in your Quadra have been revised & updated. The following patch facsimile sheets represent these updated voices. Although some of these new voices are fairly similar to patches indicated in the back of the Quadra Owner's Manual, others represent totally new sounds. All of these patches were donated by ARP's Regional product specialists and some popular ARP users who have discovered the new sounds during this past year. Therefore, it is ARP's pleasure to share these new sounds with you!

Most patches require a general "optimum" panel setting. After panel sliders have been set to their proper position, one can select any of the 1-16 programmable voices without changing slider settings. To demonstrate this feature, set the panel sliders to the positions indicated on patch number 1. Now you may select any of the voices 1 through 16. Naturally, these are only a few of the sounds the Quadra is capable of producing. To demonstrate the sheer variety of sounds available to you on this instrument, patches 9 through 16 can be further "fine tuned" utilizing a separate

slider setup for each patch. This means that you must change slider positions for each of the voices 9-16 to optimize their sounds.

Remember that any of the patches in voice locations 1-16 can be edited on your command, and you will no doubt find a combination of slider settings that suit you better than those illustrated.

1. Depress & hold C4.
2. Depress & release E5.
3. Release C4.

2. VOICES with PHASED STRINGS

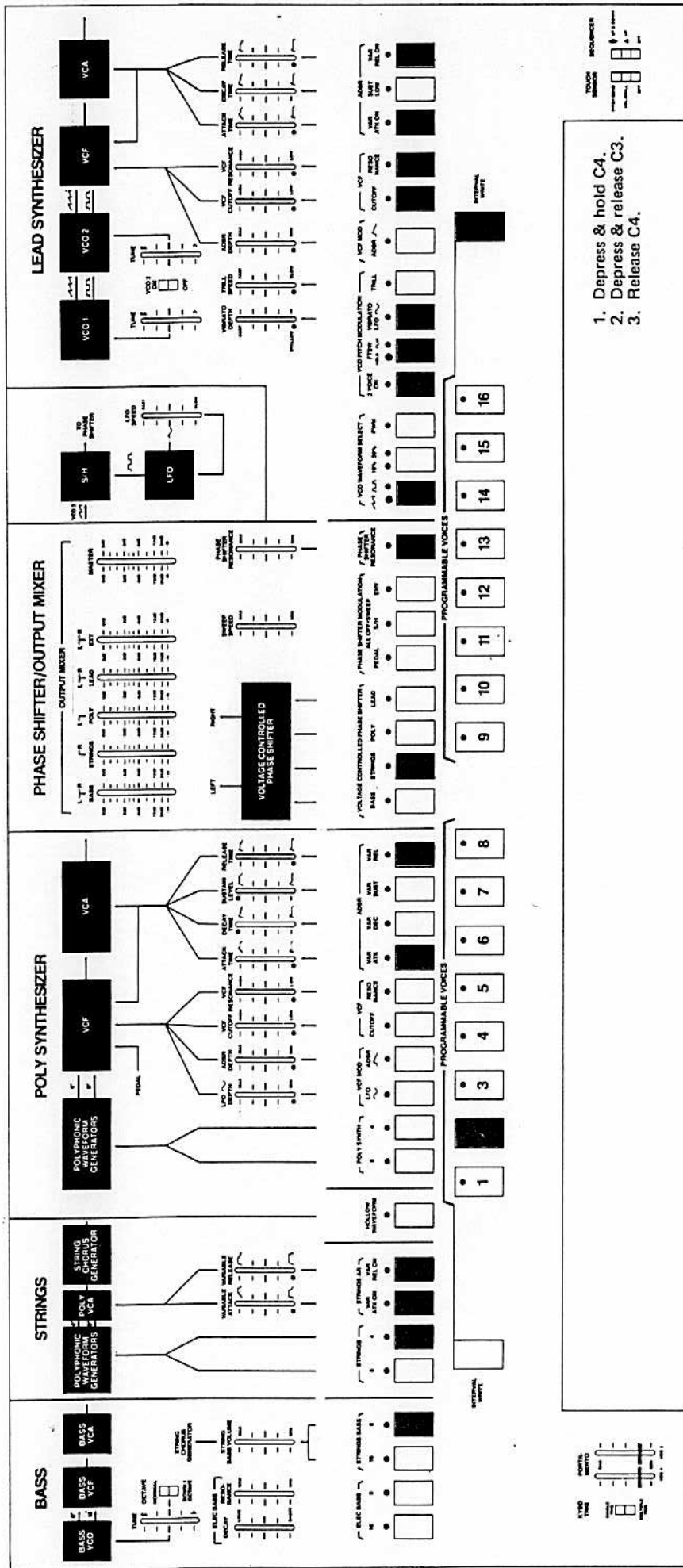

NOTE: Since the slider positions on patches 1-8 remain the same, we will not repeat them, except to show occasional exceptions, such as the Portamento sliders illustrated here.

3. FAT BRASS CHOIR with BASS

BASS

STRINGS

POLY SYNTHESIZER

PHASE SHIFTER/OUTPUT MIXER

LEAD SYNTHESIZER

PROGRAMMABLE VOICES

1	2	3	4	5	6	7	8	9	10	11	12	13	14	15	16
---	---	---	---	---	---	---	---	---	----	----	----	----	----	----	----

EXTERNAL WHITE

TOUCH SENSITIVE RESONANCE

1. Depress & hold C2.
2. Depress & release C1.
3. Release C2.

4. SAX/BRASS SECTION

BASS

STRINGS

POLY SYNTHESIZER

LEAD SYNTHESIZER

PHASE SHIFTER/OUTPUT MIXER

VOLTAGE CONTROLLED PHASE SHIFTER

BASS

STRINGS

POLY

LEAD

PROGRAMMABLE VOICES

PROGRAMMABLE VOICES

INTERNAL WHITE

INTERNAL WHITE

LEAD TIME

POLY TIME

TOUCH SENSITIVE

REORDER

1. Depress & hold C3.
2. Depress & release C2.
3. Release C3.
4. Tap & release footswitch when sounding chords.

5. PERCUSSIVE FUNK

BASS

STRINGS

POLY SYNTHESIZER

PHASE SHIFTER/OUTPUT MIXER

LEAD SYNTHESIZER

PROGRAMMABLE VOICES

1	2	3	4	5	6	7	8
9	10	11	12	13	14	15	16

INTERNAL WRITE

INTERNAL WRITE

PROGRAMMABLE VOICES

1	2	3	4	5	6	7	8
9	10	11	12	13	14	15	16

TOUCH SENSOR

MEMORIZER

1. Depress & hold C2.
2. Depress & release C1.
3. Release C2.

6. PERCUSSIVE TWO-VOICE BELLS

BASS

BASS VCO
BASS VCF
BASS VCA

TIME
DECAY
SUSTAIN
RELEASE

ELC BASE
REC'D
MIXED

STRING COMPACTOR
BASE VOLUME

STRINGS

POLYPHONIC WAVEFORM GENERATORS
POLY VCA
STRING CHORUS GENERATOR

STRINGS
ATTEN
MIX
MIX

STRINGS BASE
ATTEN
MIX
MIX

POLY SYNTHESIZER

POLYPHONIC WAVEFORM GENERATORS
POLY VCF
POLY VCA

PEDAL
VCO 1
VCO 2
VCF
VCA

LEAD
VCO 1
VCO 2
VCF
VCA

ATTACK
DECAY
SUSTAIN
RELEASE

PHASE SHIFTER/OUTPUT MIXER

OUTPUT MIXER
LFT
RHT

VOLTAGE CONTROLLED PHASE SHIFTER

LEAD SYNTHESIZER

VCO 1
VCO 2
VCF
VCA

TIME
DECAY
SUSTAIN
RELEASE

VORATO
MIXED
MIXED

VCO 1
VCO 2
VCF
VCA

ATTACK
DECAY
SUSTAIN
RELEASE

PROGRAMMABLE VOICES

1 2 3 4 5 6 7 8 9 10 11 12 13 14 15 16

INTERNAL SWPTE

RESOURCES

1. Depress & hold C4.
2. Depress & release C3.
3. Release C4.

7. FUNK POWER BLAST

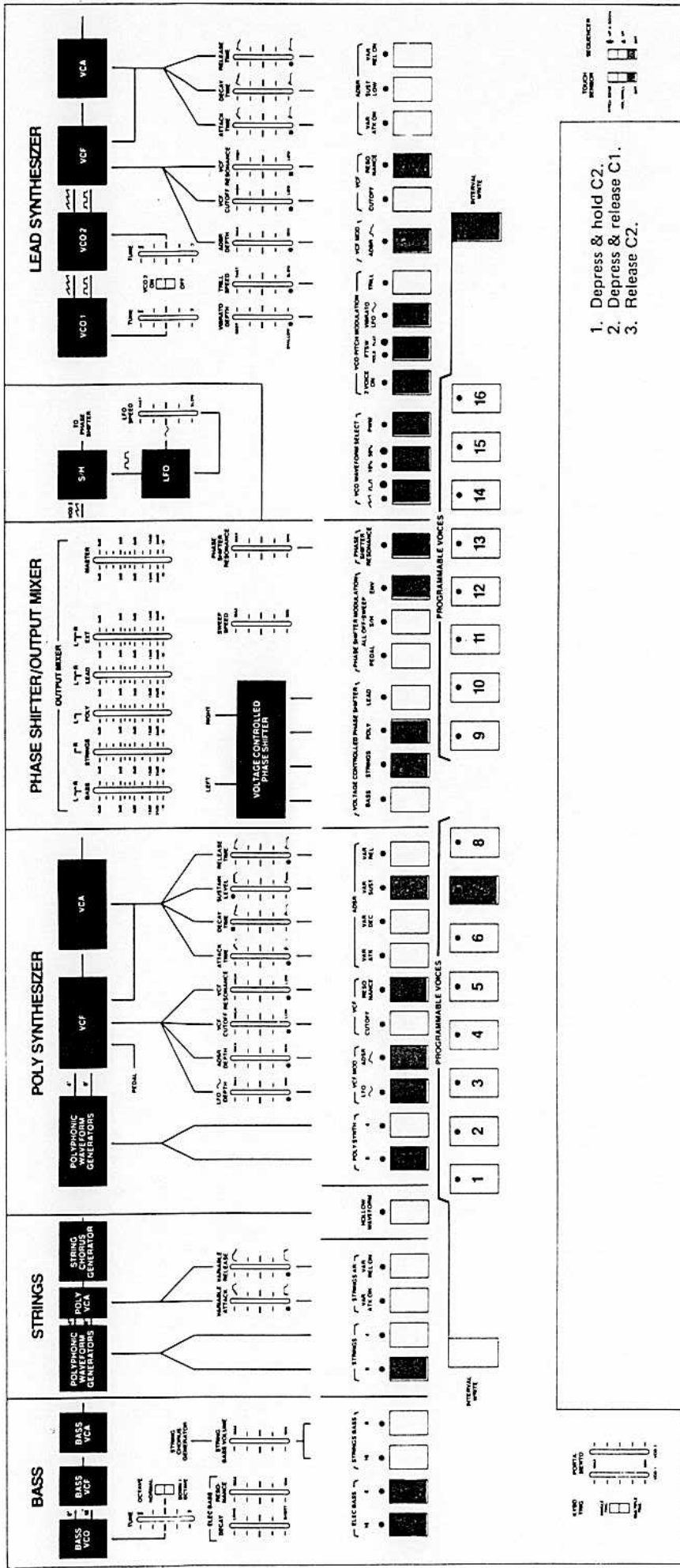

1. Depress & hold C2.
2. Depress & release C1.
3. Release C2.

8. SCRELECH BRASS ORCHESTRA

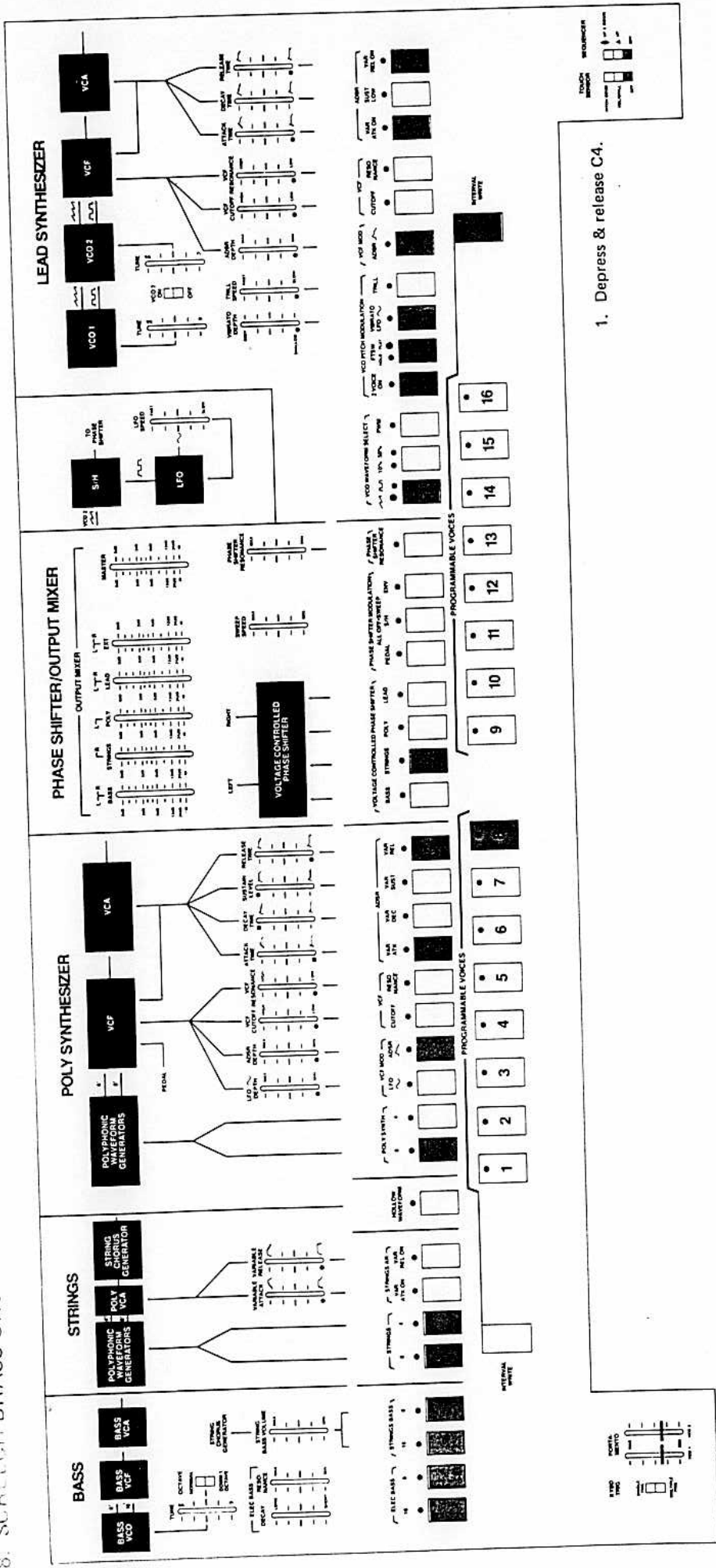

1. Depress & release C4.

9. TOUCH-SENSITIVE ORCHESTRA

BASS

Controls: Bass VCO (Time, Octave), Bass VCF (Cutoff, Resonance), Bass VCA (Attack, Decay, Sustain, Release), Polyphonic Waveform Generators (Waveform, Amplitude), String Chorus Generator (Mix, Depth, Rate).

STRINGS

Controls: Polyphonic Waveform Generators (Waveform, Amplitude), Poly VCF (Cutoff, Resonance), Poly VCA (Attack, Decay, Sustain, Release), String Chorus Generator (Mix, Depth, Rate).

POLY SYNTHESIZER

Controls: Polyphonic Waveform Generators (Waveform, Amplitude), VCF (Cutoff, Resonance), VCA (Attack, Decay, Sustain, Release).

PHASE SHIFTER/OUTPUT MIXER

Controls: Output Mixer (L, R, M, S, T, B, C, D, E, F, G, H, I, J, K, L, M, N, O, P, Q, R, S, T, U, V, W, X, Y, Z), Voltage Controlled Phase Shifter (Phase, Amplitude).

LEAD SYNTHESIZER

Controls: VCO 1 (Time, Waveform), VCO 2 (Time, Waveform), VCF (Cutoff, Resonance), VCA (Attack, Decay, Sustain, Release), LFO (Rate, Depth), S/R (Sustain, Release).

PROGRAMMABLE VOICES

1	2	3	4	5	6	7	8
9	10	11	12	13	14	15	16

EXTERNAL MEMORY

TOUCH SENSITIVE ORCHESTRA

1. Depress & release C2.
2. Use Touch Sensor for expression.

11. ETHERIALISM

BASS

BASS VCO
BASS VCF
BASS VCA

OSCILLATOR
LFO

OSCILLATOR
LFO

STRINGS

POLYPHONIC GENERATORS
POLYPHONIC GENERATORS
POLYPHONIC GENERATORS
POLYPHONIC GENERATORS

OSCILLATOR
LFO

OSCILLATOR
LFO

POLY SYNTHESIZER

POLYPHONIC GENERATORS
VCF
VCA

OSCILLATOR
LFO

OSCILLATOR
LFO

PHASE SHIFTER/OUTPUT MIXER

OUTPUT MIXER

VOLTAGE CONTROLLED PHASE SHIFTER

LEAD SYNTHESIZER

VCO 1
VCO 2
VCF
VCA

OSCILLATOR
LFO

OSCILLATOR
LFO

PROGRAMMABLE VOICES

1 2 3 4 5 6 7 8

9 10 11 12 13 14 15 16

INTERNAL WHITE

TOUCH SENSITIVE

TOUCH SENSITIVE

1. Depress & hold C4.
2. Depress & release C3.
3. Release C4.
4. Load Trill for 1 octave interval (see Trill section, page 22).
5. Depress Sustain footswitch.
6. Play impressionistic music.

12. SPACIAL ENCOUNTERS

BASS

STRINGS

POLY SYNTHESIZER

PHASE SHIFTER/OUTPUT MIXER

LEAD SYNTHESIZER

ELC BASS

1. STINGS LA

2. STINGS AT

3. STINGS RE

4. STINGS DE

5. STINGS BA

6. STINGS TR

7. STINGS BR

8. STINGS RL

9. STINGS RR

10. STINGS LR

11. STINGS LL

12. STINGS LR

13. STINGS LR

14. STINGS LR

15. STINGS LR

16. STINGS LR

STRINGS

1. STINGS LA

2. STINGS AT

3. STINGS RE

4. STINGS DE

5. STINGS BA

6. STINGS TR

7. STINGS BR

8. STINGS RL

9. STINGS RR

10. STINGS LR

11. STINGS LL

12. STINGS LR

13. STINGS LR

14. STINGS LR

15. STINGS LR

16. STINGS LR

POLY

1. POLY LA

2. POLY AT

3. POLY RE

4. POLY DE

5. POLY BA

6. POLY TR

7. POLY BR

8. POLY RL

9. POLY RR

10. POLY LR

11. POLY LL

12. POLY LR

13. POLY LR

14. POLY LR

15. POLY LR

16. POLY LR

PHASE SHIFTER

1. PHASE LA

2. PHASE AT

3. PHASE RE

4. PHASE DE

5. PHASE BA

6. PHASE TR

7. PHASE BR

8. PHASE RL

9. PHASE RR

10. PHASE LR

11. PHASE LL

12. PHASE LR

13. PHASE LR

14. PHASE LR

15. PHASE LR

16. PHASE LR

LEAD

1. LEAD LA

2. LEAD AT

3. LEAD RE

4. LEAD DE

5. LEAD BA

6. LEAD TR

7. LEAD BR

8. LEAD RL

9. LEAD RR

10. LEAD LR

11. LEAD LL

12. LEAD LR

13. LEAD LR

14. LEAD LR

15. LEAD LR

16. LEAD LR

PROGRAMMABLE VOICES

1. VOICE 1

2. VOICE 2

3. VOICE 3

4. VOICE 4

5. VOICE 5

6. VOICE 6

7. VOICE 7

8. VOICE 8

9. VOICE 9

10. VOICE 10

11. VOICE 11

12. VOICE 12

13. VOICE 13

14. VOICE 14

15. VOICE 15

16. VOICE 16

CONTROL PANEL

1. HOLD

2. TRILL

3. HOLD

4. HOLD

5. HOLD

6. HOLD

7. HOLD

8. HOLD

9. HOLD

10. HOLD

11. HOLD

12. HOLD

13. HOLD

14. HOLD

15. HOLD

16. HOLD

INSTRUCTIONS

1. Depress & hold C2.
2. Depress & release F2.
3. Release C2.
4. Load Trill for a perfect 4th interval (see Trill section, page 22).
5. Latch the Lead section with Hold footswitch, and play over the latched sound.

13. BASS-TRIGGERED PHASER

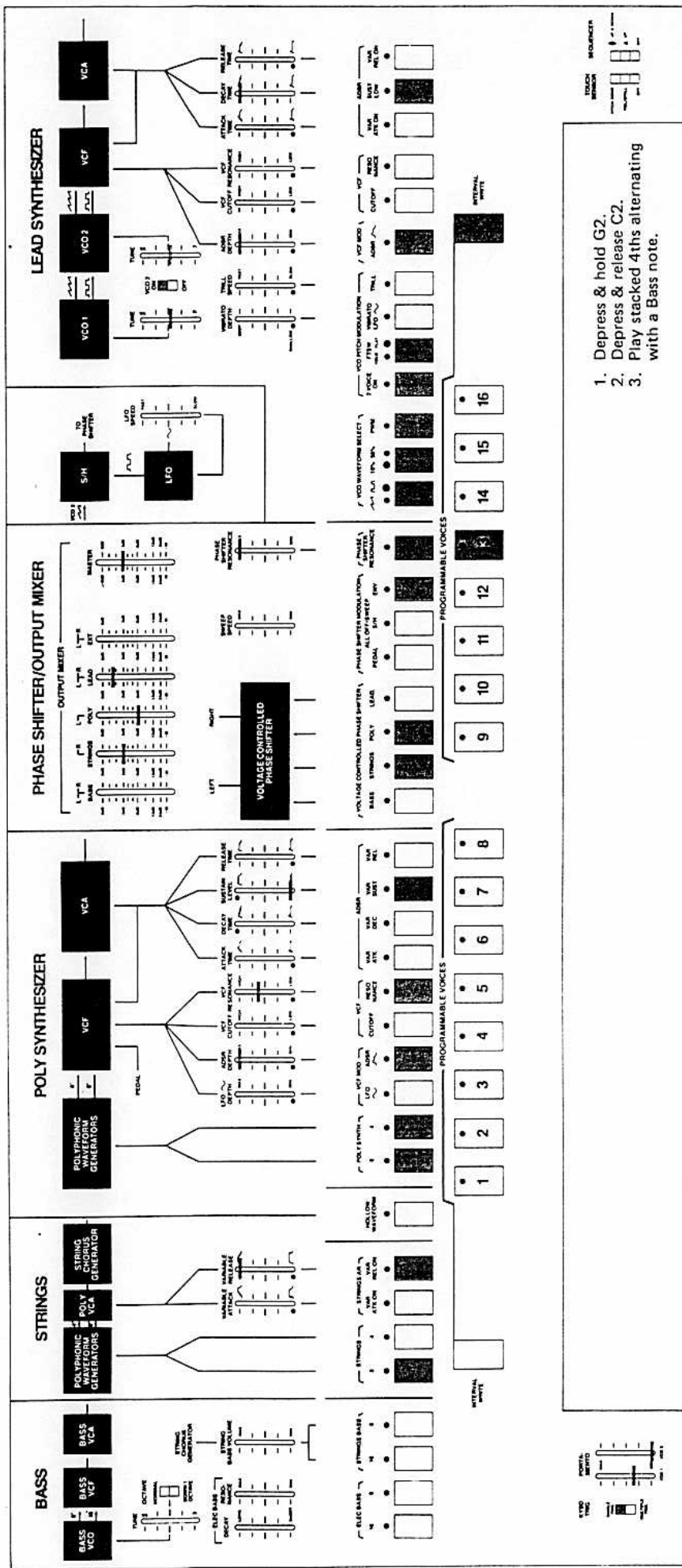

1. Depress & hold G2.
2. Depress & release C2.
3. Play stacked 4ths alternating with a Bass note.

15. HARPSICHORD & STRINGS with LOW BRASS

BASS

STRINGS

POLY SYNTHESIZER

PHASE SHIFTER/OUTPUT MIXER

LEAD SYNTHESIZER

CONTROL PANEL

FUNCTION SELECTORS

- BASS VCO: TIME, OCTAVE, BASS VCF, BASS VCA
- STRINGS: POLYPHONIC WAVEFORM GENERATORS, STRING CHORUS POLY VCA, FILTER, ENVELOPE
- POLY SYNTHESIZER: POLYPHONIC WAVEFORM GENERATORS, VCF, VCA, FILTER, ENVELOPE
- PHASE SHIFTER: PHASE SHIFTER, POLY, LEAD, RIGHT, LEFT, VOLTAGE CONTROLLED PHASE SHIFTER
- LEAD SYNTHESIZER: VCO 1, VCO 2, VCF, VCA, FILTER, ENVELOPE

PROGRAMMABLE VOICES

1 2 3 4 5 6 7 8 9 10 11 12 13 14 15 16

EXTERNAL SPEAKER

INSTRUCTIONS

1. Depress C1.
2. Use Touch Sensor for expression.

PATCHES

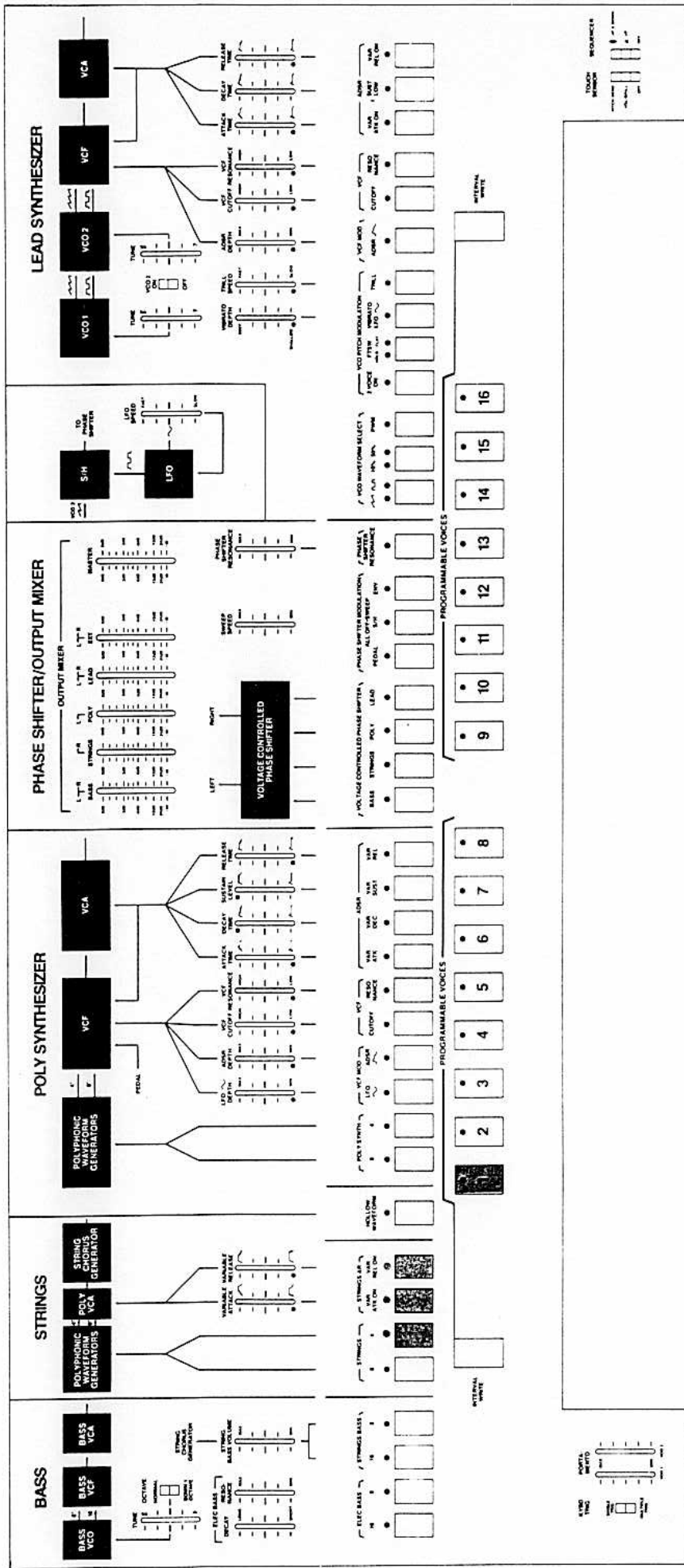

These patches represent the sixteen factory-programmed voices which are loaded in the memory of your Quadra at time of purchase. If you should accidentally erase one of these voices, and wish to reload it, read over the MEMORY LOADING section of this manual on page 39, then simply set up the patch you wish to load. In these examples, no slider positions are shown, since they are unnecessary to the loading process. When you play the instrument, you will find it helpful to leave all sliders in the midway position, and adjust them to suit your taste after changing voices.

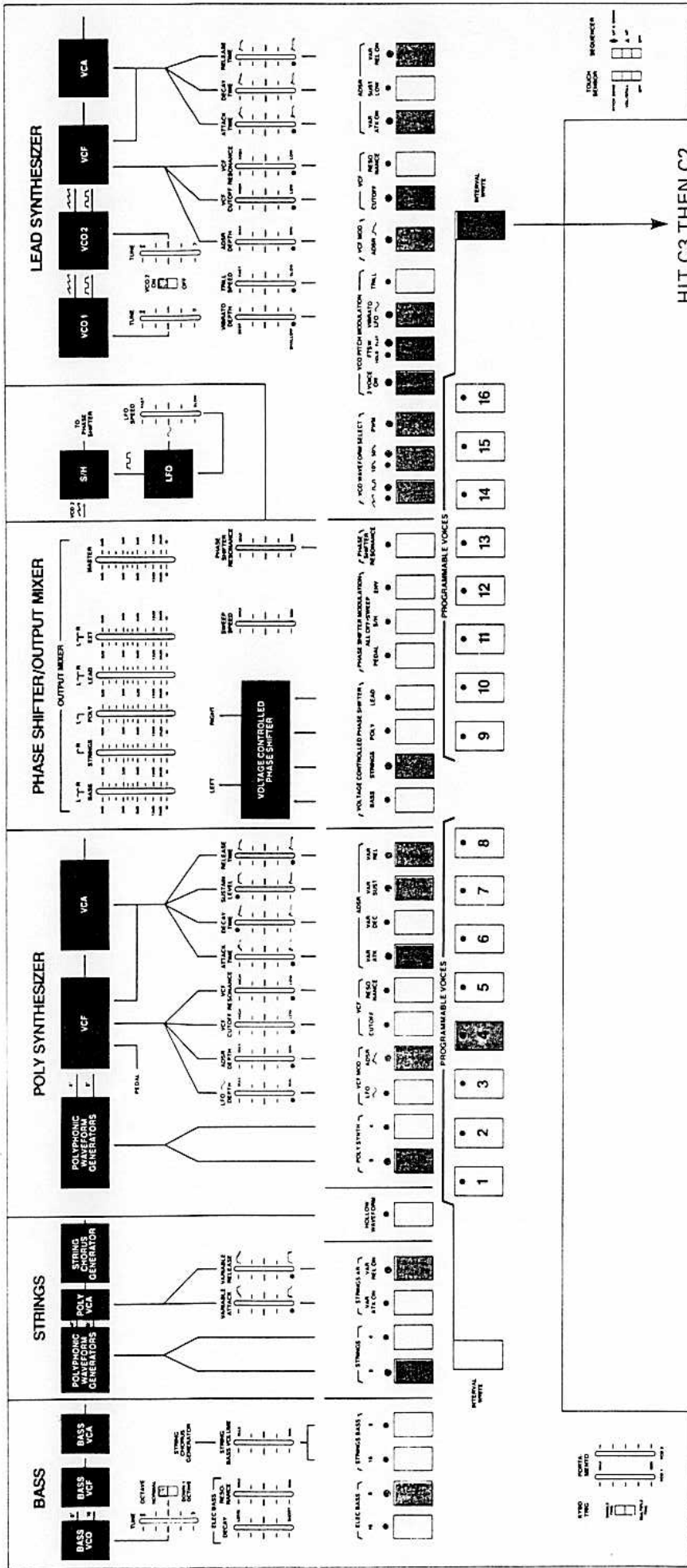

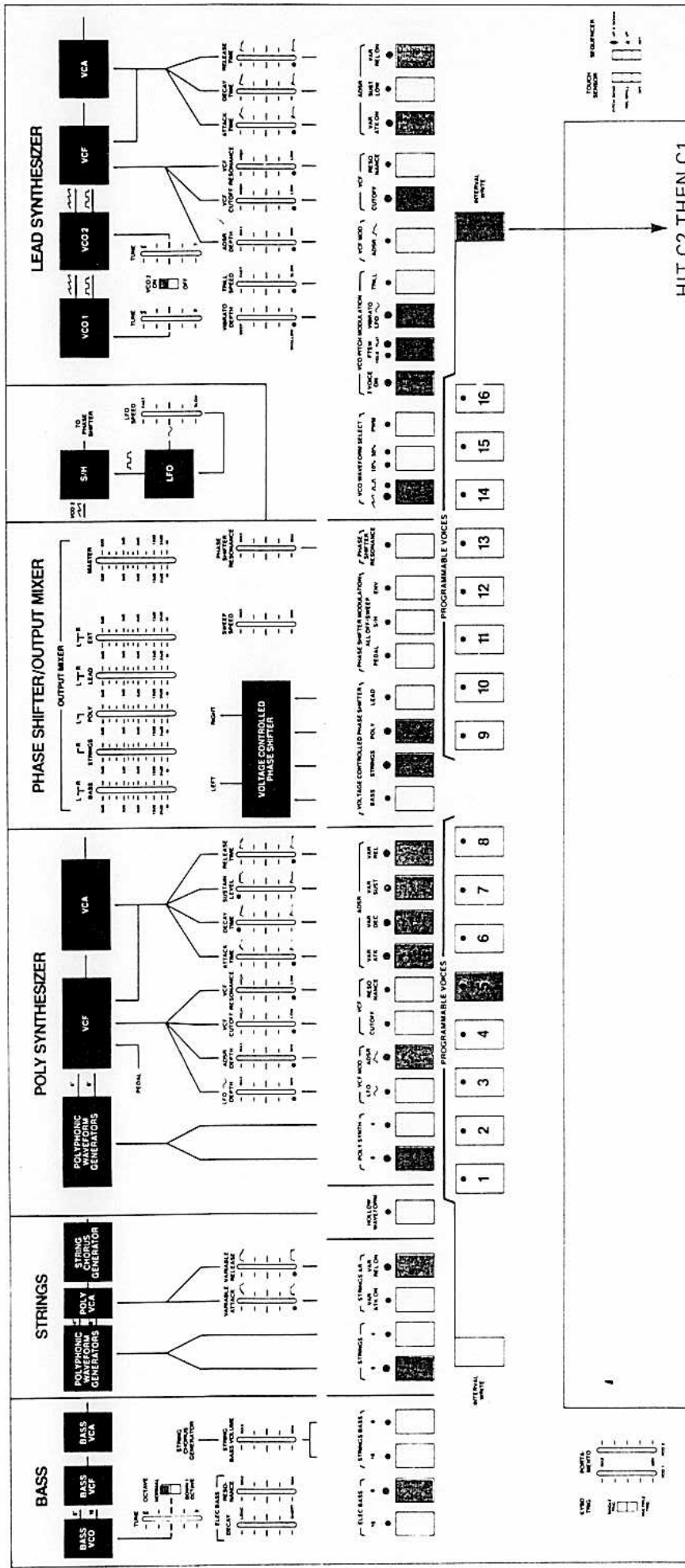

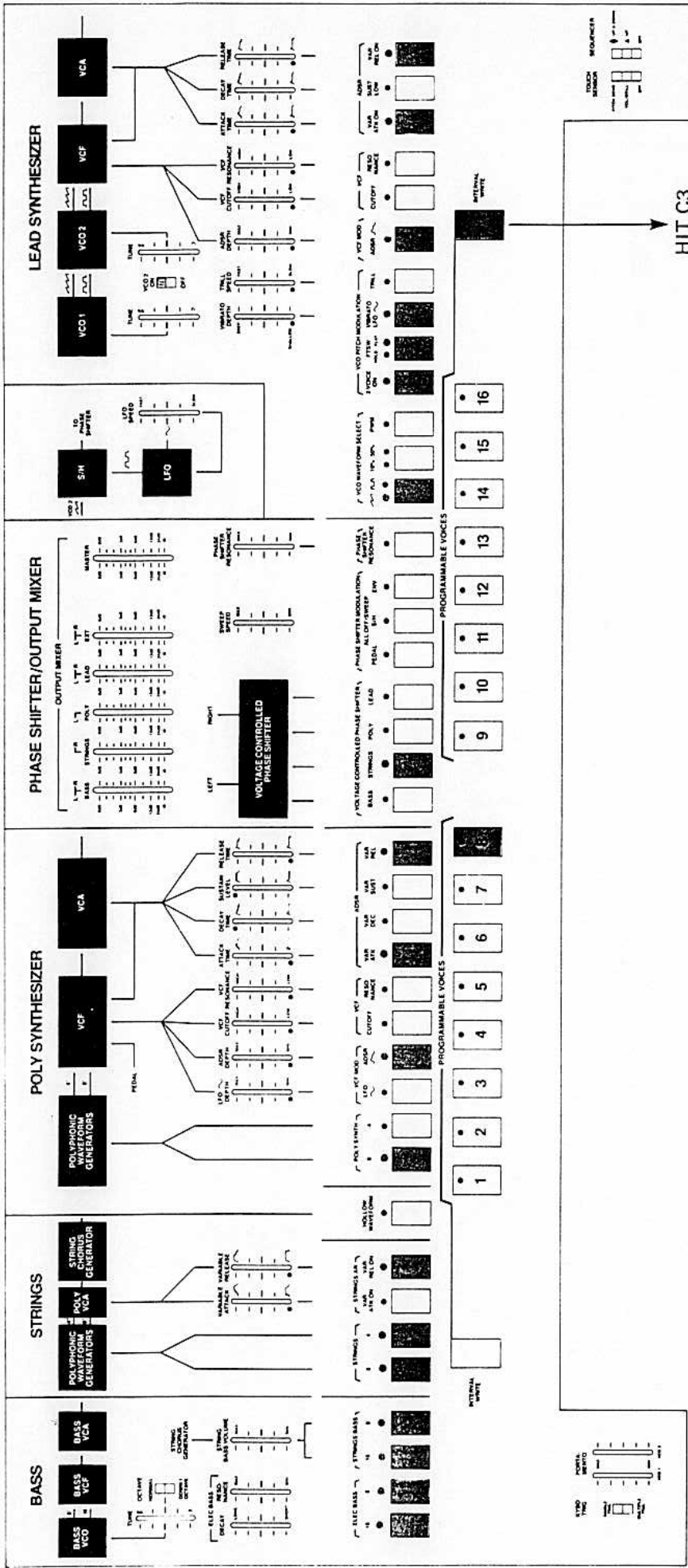

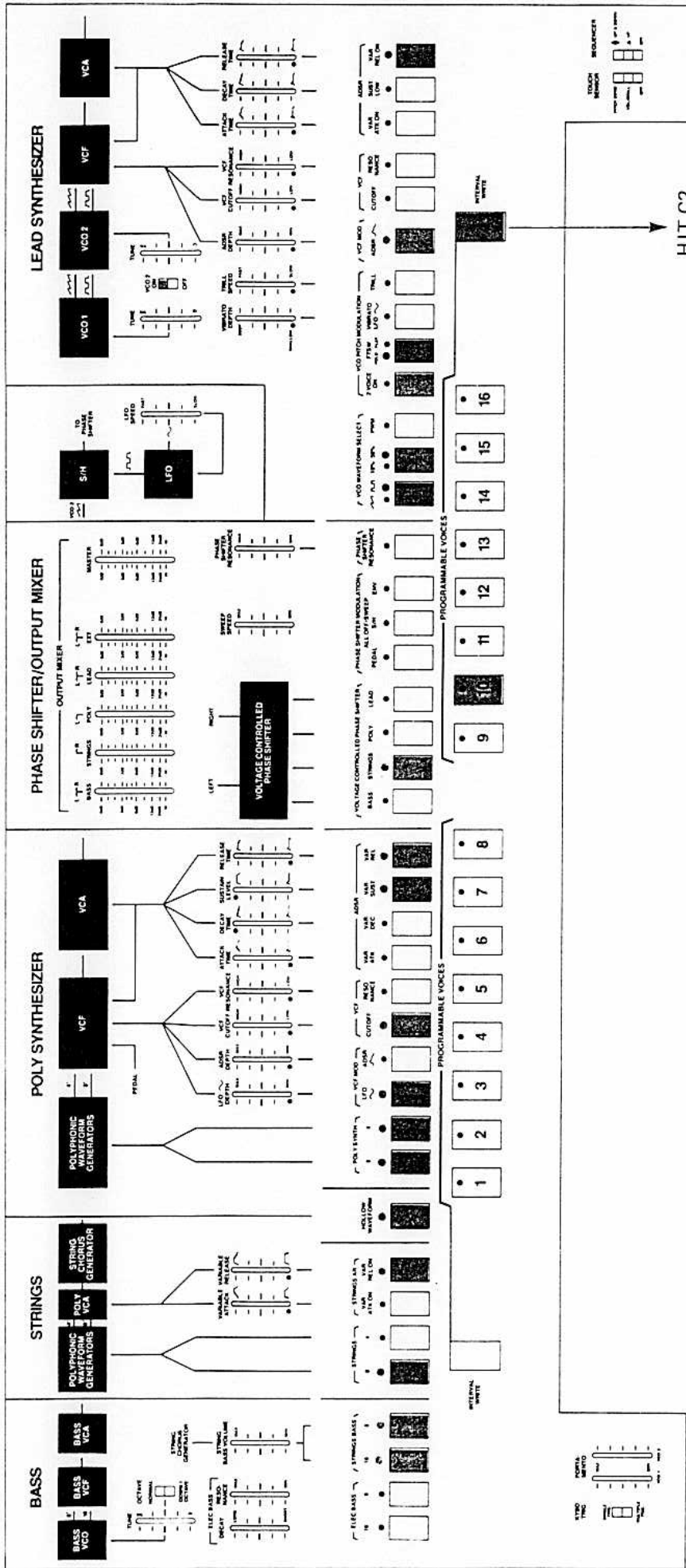

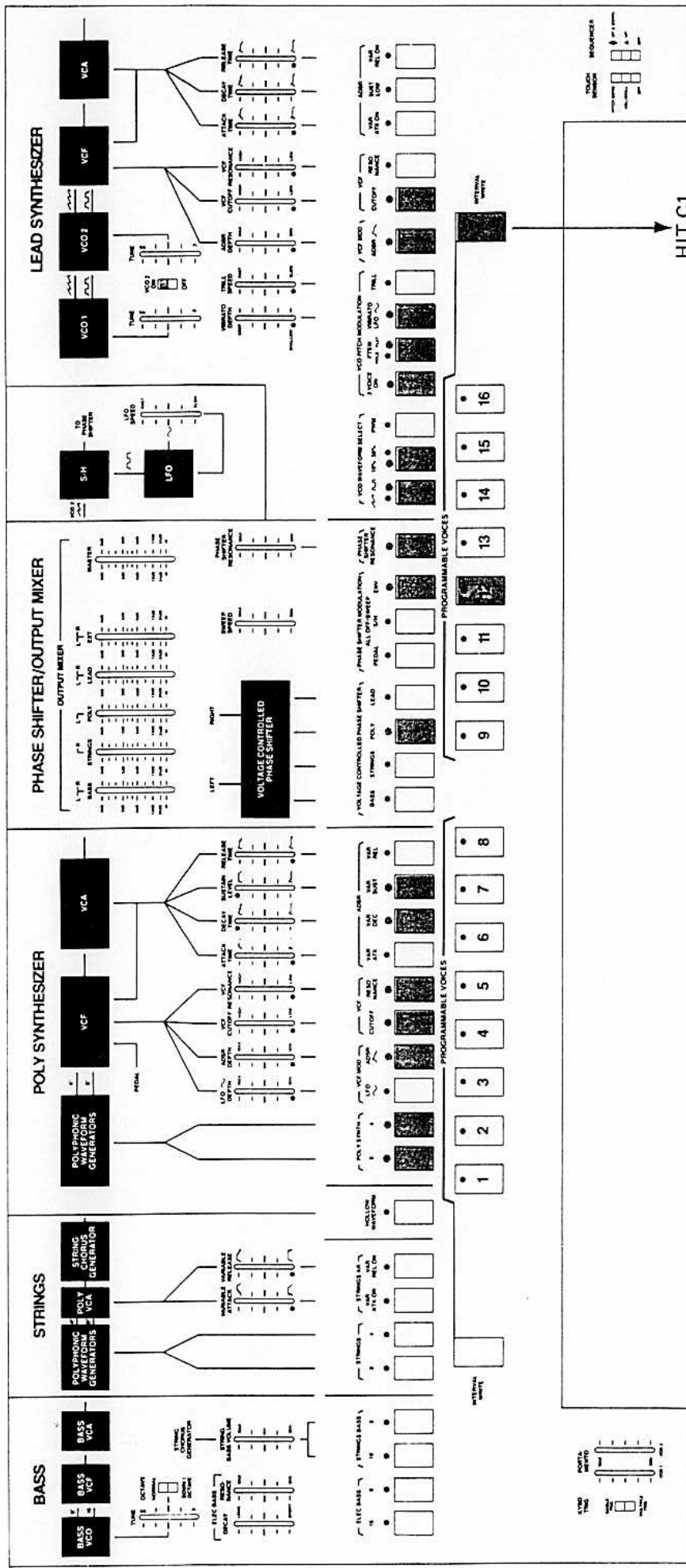

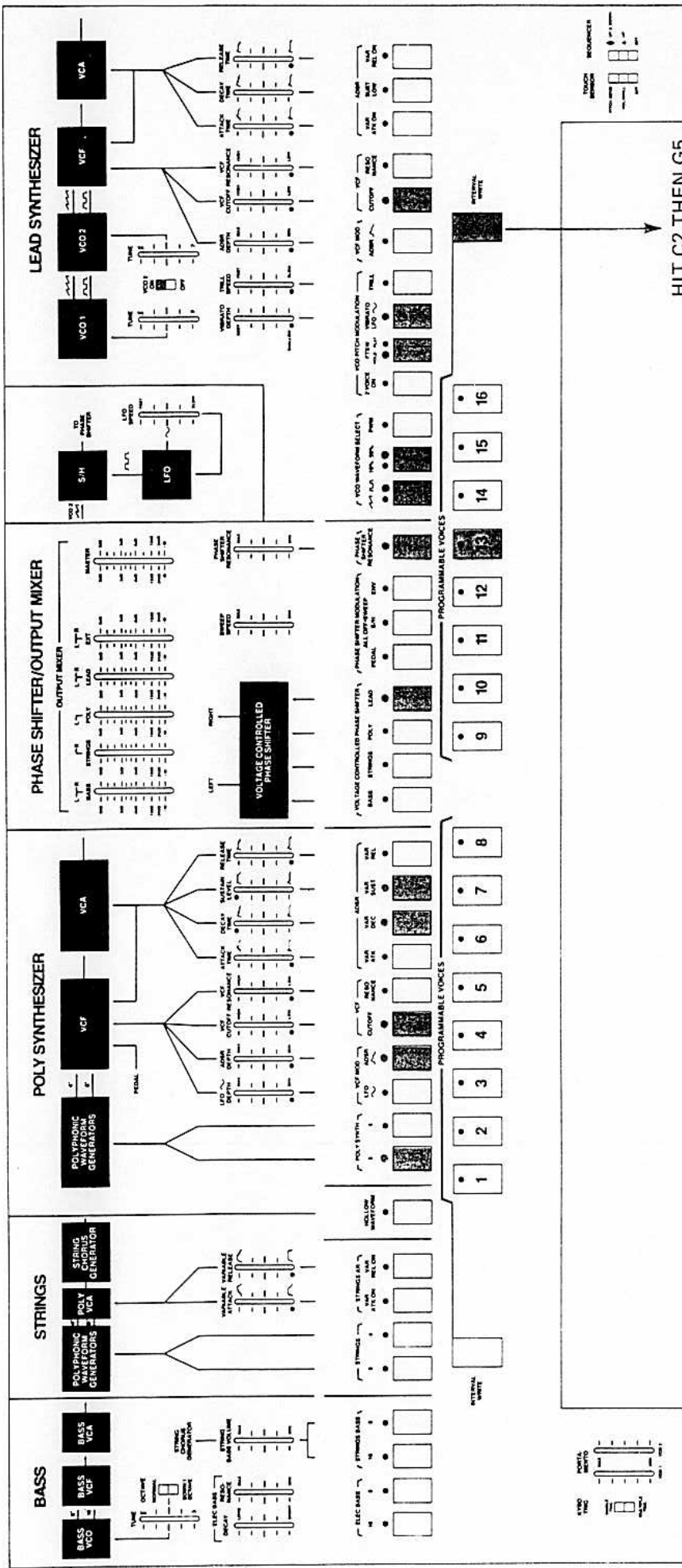

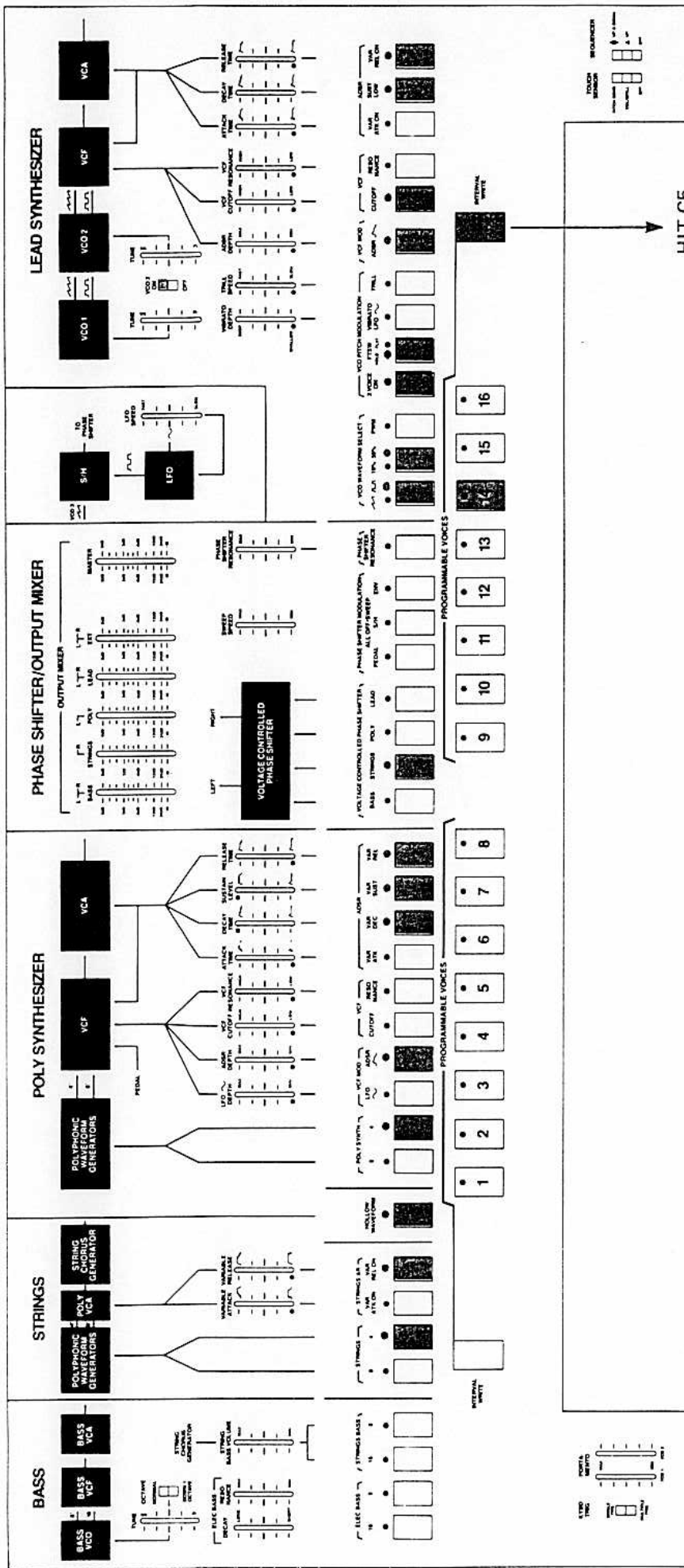

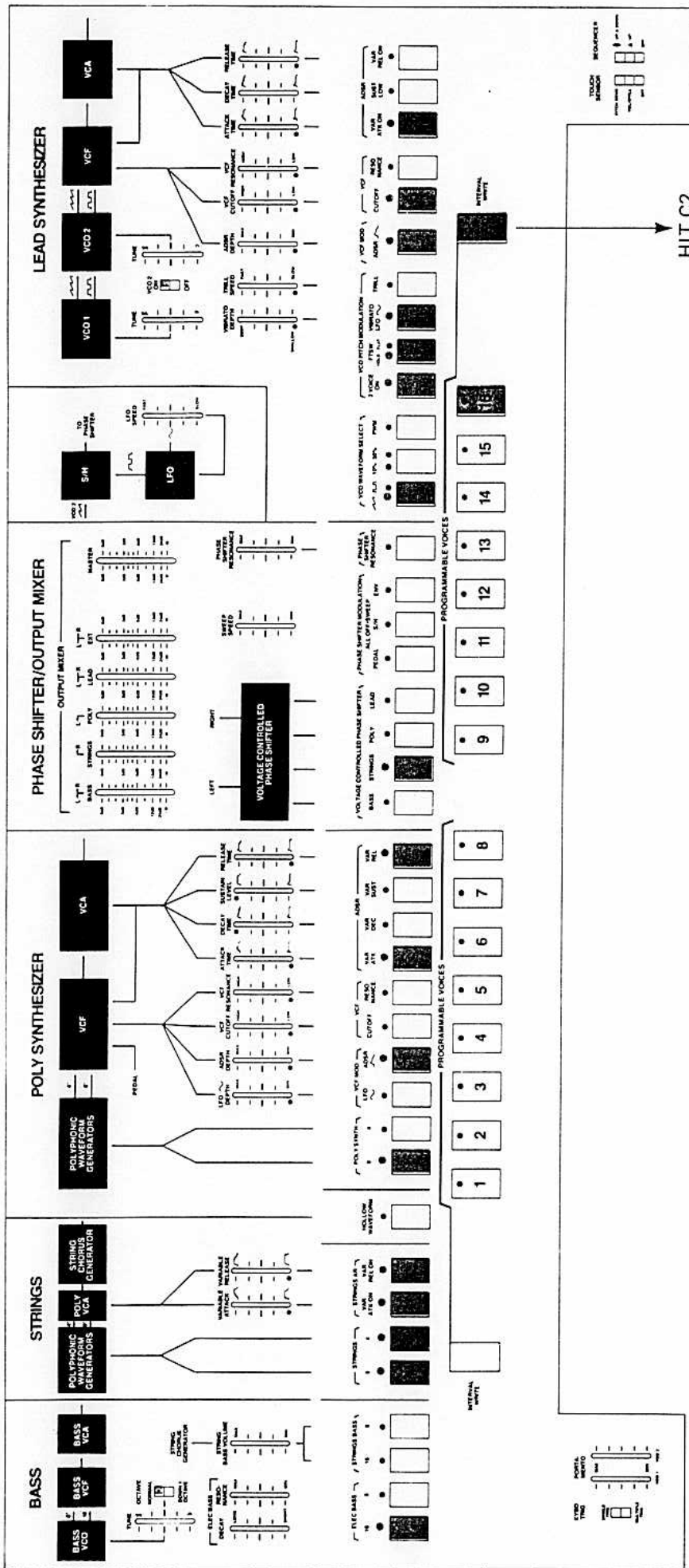

SPECIFICATIONS

VCO (BASS)

Frequency Range: 65Hz to 250Hz
Waveform: Pulse

VCO (LEAD)

Frequency Range: 16Hz to 16KHz
Waveforms: Sawtooth, Square, 10% Pulse
Maximum Vibrato Depth: Approximately ± 1 semitone
Maximum Trill Depth: 5 octaves
Pulse Width Modulation Range: 10% mode, 25%-60%
50% mode, 60%-80%

VCF (POLY SYNTH)

Type: Low Pass, 24db/octave
Frequency Range: 16Hz to 16KHz
Resonance: Maximum usable Q=30
Maximum LFO Modulation: ± 1 octave
ADSR Sweep: Minimum 5 octaves, Maximum 8 octaves

VCF (LEAD)

Specifications similar to above except:
ADSR Sweep: Minimum 2 octaves, Maximum 8 octaves

LFO

Frequency Range: .5Hz to 15Hz
Waveforms: Sine, Square (via S/H)

TRILL

Trill Speed Range: 2Hz to 20Hz

ENVELOPE GENERATOR (BASS)

Maximum Decay Time: 5 seconds

ENVELOPE GENERATOR (STRINGS)

Maximum Attack Time: 6 seconds
Maximum Release Time: Variable option, 3 seconds
Preset option, 1 second

ENVELOPE GENERATOR (POLY SYNTH)

Maximum Attack Time: 1 second
Maximum Decay Time: Variable option, 2 seconds
Preset option, 2 seconds
Maximum Sustain Level: Variable option, 3V
Preset option, 3V
Maximum Release Time: 3 seconds

ENVELOPE GENERATOR (LEAD)

Maximum Attack Time: 1 second
Maximum Decay Time: SUST LOW off, .4 seconds
SUST LOW on, 2 seconds
Maximum Release Time: 2.5 seconds

PORTAMENTO

Minimum Speed: 1.5 seconds/octave

S/H

Max. Frequency Deviation in Phase Shifter: 1 octave

TOUCH SENSOR

Maximum Pitch Deviation: +3 semitones

PHASE SHIFTER

Sweep Speed Range: .1Hz to 5Hz

INTERFACE JACKS

CV IN/OUT: 1V/octave
GATE IN: Minimum 2.5V (Lead & Bass)
GATE OUT: Approximately 10V (Lead & Bass)
TRIG IN: 8V Pulse, 10 microseconds minimum duration
TRIG OUT: 10V Pulse, 60 microseconds duration

EXTERNAL AUDIO IN

Input Specifications: 7V input=5V maximum output

AUDIO OUTPUTS

Impedance: 680 ohms, all audio outputs

MONO OUT (XLR & 1/4" phone):

High=10VP-P maximum
Low=1VP-P maximum

QUAD OUT

Bass=5VP-P maximum
Strings=10VP-P maximum
Poly Synth=12VP-P maximum
LEAD=3VP-P maximum

STEREO OUT (Left & Right): 10VP-P maximum