



# MODEL 3620 KEYBOARD SERVICE MANUAL

*THIS SERVICE MANUAL SHOULD BE USED WITH THE ARP 2600 SERVICE MANUAL*

## TABLE OF CONTENTS

1. 3620 DESCRIPTION	
1.1 Introduction	2
1.2 Specifications	2
1.3 Function Descriptions	2
2. CIRCUIT DESCRIPTIONS	
2.1 Keyboard Current Source	4
2.2 Second Voice Memory	4
2.3 Upper Voice Summation	4
2.4 Control Voltage Memory	4
2.5 Master Summation	4
2.6 Gate Generator	4
2.7 Memory Control	5
2.8 Low Frequency Oscillator	5
2.9 Vibrato Delay & Wave Shaping	5
3. TRIMS & ADJUSTMENTS	6
4. BOARD TEST POINTS	7
5. 3620 THREE BUS CONVERSION BOARD	8
6. 3620 CONTACT MAINTENANCE	9
7. ASSEMBLY/DISSASSEMBLY	9
8. 3620 DRAWINGS	
8.1 Board Layout	10
8.2 Board Schematic	11
9. PARTS LIST	13
10. REVISIONS	----

ARP INSTRUMENTS, INC.  
45 Hartwell Avenue  
Lexington, MA 02173  
(617) 861-6000

© 1977, ARP INSTRUMENTS, INC.

## SECTION 1 3620 DESCRIPTION

### 1.1 INTRODUCTION

The 3620 keyboard replaces the 3604P keyboard for the 2600P synthesizer. Features included are: two separate memorized control voltages, interval latch, repeat modes, LFO, delayed vibrato, transpose and pitch bend controls.

This manual should be used in conjunction with the 2600 service manual for complete understanding of the functions it contains.

### 1.2 SPECIFICATIONS

UPPER VOICE CV OUTPUT: -3 volts to +10 volts,  
1V/OCT

LOWER VOICE CV OUTPUT: -3 volts to +7 volts,  
1V/OCT

LFO TRIANGLE OUTPUT:  $\pm 5$  volts, 10 volts peak  
to peak

LFO SQUARE WAVE OUTPUT: +10 volts, 10 volts  
peak to peak

LFO DELAYED SINE WAVE OUTPUT:  $\pm 3$  volts,  
6 volts peak to peak

EXTERNAL VIBRATO INPUT: Accepts  $\pm 10$  volts  
maximum

VIBRATO DEPTH SLIDER: 10 volts yields approx.  
1 octave shift

VIBRATO DELAY SLIDER: Delays sine wave from  
0 sec. to approx. 2.5 seconds

LFO SPEED SLIDER: .25Hz to approx. 25Hz

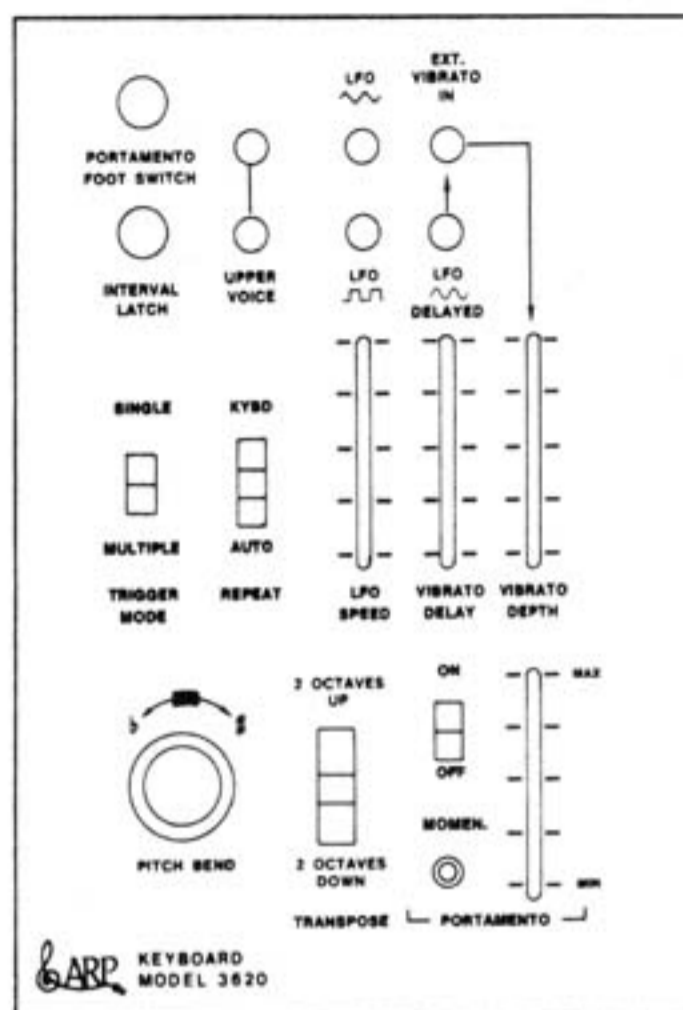

PITCH BEND CONTROL:  $\pm 1$  octave, calibrated

TRANSCOPE SWITCH:  $\pm 2$  octaves, calibrated

PORTAMENTO SPEED SLIDER: 1msec. to approx.  
2sec.

PORTAMENTO FOOT SWITCH: Accepts only ARP  
foot switch

INTERVAL FOOT SWITCH: Accepts only ARP foot  
switch

GATE OUTPUT (ON 2600 PANEL): 0 volts keys up,  
+10 volts key down

TRIGGER OUTPUT (ON 2600 PANEL): +10 volts  
on key depression, .5msec duration

### 1.3 FUNCTION DESCRIPTIONS

CONTROL	CIRCUIT FUNCTION	MUSICAL USE
PITCH BEND CONTROL	When turned clockwise or counter-clockwise from center, an offset voltage is summed with the upper and lower voice control voltages. The Pitch Bend control is calibrated to a maximum $\pm 1$ octave.	Manually 'Bends' the pitch of the oscillators sharp or flat. Also can be used as a $\pm 1$ octave transpose.
TRANSCOPE SWITCH	Up and down two octave positions sum $\pm 2$ V offset voltage with upper and lower voice control voltages.	Changes the playing range of keyboard.

CONTROL	CIRCUIT FUNCTION	MUSICAL USE
PORTAMENTO ON/OFF SWITCH	Turns on portamento circuit. Upper Voice memory is disabled when in the 'on' position.	Allows notes to slide from one pitch to another.
PORTAMENTO MEMORY PUSH BUTTON	Provides the same function as portamento on/off switch.	Allows momentary control of portamento effect.
PORTAMENTO SLIDER	Increases Portamento time from 1msec. to 2sec.	Manually controls speed of portamento effect.
TRIGGER MODE SWITCH	Multiple mode provides a trigger to the envelope generators for each key depression; single mode provides a trigger for the first key depression only.	Single mode provides attack on first key down, but not on second.
REPEAT SWITCH	In the auto Repeat mode, the LFO square wave is supplied to the envelope generator instead of the keyboard gate; in the Keyboard Repeat mode, the square output wave of the LFO is supplied to the envelope generator only while a key is held.	Allows the envelope generators to be triggered by the LFO instead of by key depressions.
LFO SPEED SLIDER	Varies the LFO speed from .25Hz to 25Hz.	Controls Vibrato rate and repeat speed.
VIBRATO DELAY SLIDER	Delays the vibrato from 0 to 2.5sec. after key depression.	Allows vibrato to 'fade' in after key is depressed.
VIBRATO DEPTH SLIDER	Attenuates the vibrato signal supplied to upper and lower control voltages.	Varies the degree of frequency shift of vibrato.
EXT. VIBRATO IN JACK	Sums external signals to upper and lower voice control voltages through the vibrato depth slider.	Allows other (low frequency) waveforms to frequency modulate the oscillators through the upper and lower control voltages.
LFO TRIANGLE JACK	Supplies the LFO triangle waveform for use outside the keyboard.	Provides additional control of other functions in the 2600.
LFO SQUARE WAVE JACK	Supplies the LFO square wave for use outside the keyboard.	Provides additional control of other functions in the 2600.
PORTAMENTO JACK	Provides same function with foot switch as the portamento momentary push button.	Allows momentary control of portamento effect.
INTERVAL LATCH JACK	Latches (holds) second voice control voltage when foot switch is depressed.	Allows single notes to play preset intervals when foot switch is held down.
UPPER VOICE JACK	Control voltage outputs for use outside the keyboard.	Allows the upper voice control voltage to be connected to any VCO (or the VCF). (Patch to 'CV' jack on any VCO.)

**2.1 KYBD. CURRENT SOURCE**

The Keyboard Current Source supplies a constant current through forty-eight 100 ohm resistors connected in series. This resistor voltage divider chain supplies specific voltages for each key on the keyboard. The top end of the resistor string is connected to J1-5 and the low end to J1-6. The current source supplies a four volt drop across the entire resistor chain. This provides a one volt per octave control voltage to the Control Voltage Memory circuitry via the KYBD CV bus.

Pin 1 of Z1A is 4.0 volts when no keys or one key is depressed. When two keys are depressed, the contacts and bus rod short out a section of resistors in the divider chain which reduces the gain of Z1A, thereby lowering the voltage on Z1A pin 1. This voltage drop represents the 'voltage difference' between two held keys. When the difference voltage is subsequently added to the control voltage from the CV bus, a high note priority control voltage is produced.

**2.2 2ND VOICE MEMORY**

The output of Z1A is connected through Q1 to a storage capacitor, C2. When a memory trigger pulse is supplied to CR3 from the memory control, Q1 turns on which charges C2 to the voltage level on Z1A pin 1. Q2 and Z1B are an FET op amp with high input impedance to buffer the voltage on C2. The stored 'difference' voltage on pin 7 of Z1B is supplied to the upper voice inverter/summer.

**2.3 UPPER VOICE SUMMATION**

The upper voice summation sums and inverts the control voltage from the Master Summation Circuit and the 'difference' voltage from the second voice memory. The combination of these two voltages yields a high note priority control voltage. R8, the offset trimmer, supplies voltage to the summed input to set the output of Z2A to zero volts when low C is depressed. The output of Z2A is connected to the Upper Voice control voltage output jacks on the front panel.

**2.4 CONTROL VOLTAGE MEMORY**

Control voltages supplied from the keyboard bus are buffered by a unity gain amplifier, Z3A. The voltage is then supplied via the portamento slider (R21) and Q4 to memory capacitor C4. Q4 is turned on during the pulse signal (or gate signal when the portamento switch is on) which is supplied to CR6 from the memory control circuit. Q5 and Z3B are an FET follower with high input impedance to buffer the voltage on C4.

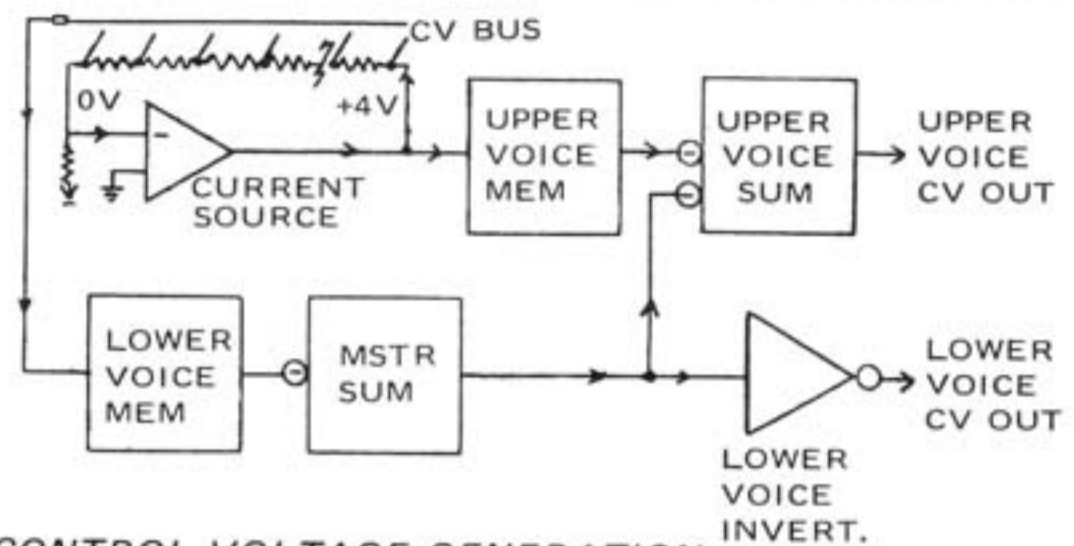

**CONTROL VOLTAGE GENERATION**

Q3 is on when the portamento switch is off which shorts out the portamento slider. Q3 is turned on by the -15 volts supplied from S4A (memory control). R2 then varies the time C4 takes to charge from one voltage level to another causing a sliding effect.

**2.5 MASTER SUMMATION**

**Pitch Bend:** The Pitch Bend control supplies an offset voltage to Z4A to be summed with the control voltage from the CV memory. CR7 and CR8 create a dead zone when the control is centered and R30 calibrates the offset to exactly  $\pm 1$  volt.

**Transpose:** The Transpose switch supplies offset voltages to Z4A to be summed with the control voltage. R34 calibrates the voltage to exactly  $\pm 2$  octaves.

Z4 is a unity gain inverter which sums the transpose, pitch bend and keyboard control voltages. R38 adds an offset voltage so that Z4A is zero volts when Low C is depressed. The control voltage on the output of Z4A is inverted; Low C will be 0 volts, high C will be -4 volts. The upper and lower voice summation circuits will re-invert these voltages to 0 and +4 volts.

**2.6 GATE GENERATOR**

Each gate contact on the keyboard is connected to a 2.2K ohm resistor to ground. When a key is depressed, the Gate Generator produces three different gate signals:

	KEY UP	KEY DOWN
GATE BUS	+15V	+10V
KYBD GATE 1	0V	+15V
KYBD GATE 2	-15V	+15V

The Gate Bus signal is supplied to the Gate/Trigger generator, Keyboard Gate 1 enables the Memory Control circuit and is supplied to the Auto/KYBD repeat circuitry.

**GATE:** When the repeat switch is in the off (mid) position, Keyboard Gate 2 is supplied to the gate output of the 3620 through CR14 and R61. R61 and R62 set the gate to +10 when a key is depressed.

**REPEAT:** When the repeat switch (S3) is in the Auto position, the gate signal through CR14 is interrupted and a low frequency +30VPP square wave from the LFO is supplied to Z5C pin 8 via R54. Z5C pin 9 is high (+15) except when a key has just been depressed. Z5C pin 10 then supplies a 0 and +15 (inverted) square wave to Q9. Q9 is turned on when the output of Z5C is low (0) which supplies +15 to the gate voltage divider R61 and 62.

When the repeat switch (S3) is in the KYBD repeat mode, CR13 clips the positive portion of the LFO square wave. Then the output of Z5C will only change state when the gate voltage is supplied to Z5C pin 8 via R51 and R53 (when a key is depressed). During the negative portion of the LFO square wave, -15 volts through CR13 defeats the Keyboard gate on Z5C pin 8 to supply a square wave on pin 10 during key depression only.

**TRIGGER:** When a key is depressed, the gate bus voltage drops from +15 volts to +10 volts; additional key depressions will drop the voltage still further. These voltage transitions are coupled through capacitor C5, R47 to Q7 which supplies +15 to the memory control circuit and the trigger generator circuit (CR11, CR6, Z5D). C6 is charged by Q7 on each key depression. Z5D is an inverter shaper. Since Z5D pin 13 is held high (+15) and pin 12 is normally low, pin 11 will be normally high. Each key depression results in a +15 and 0 VPP trigger on Z5D which is supplied to Z5C and the LFO. Z5C pin 10 will momentarily switch from low to high during the pulse from Z5D which is then coupled to Q8 through C8. Q8 shapes the pulse and R57 and R58 voltage divide the trigger to +10 VPP

## 2.7 MEMORY CONTROL

When a key is depressed, a trigger pulse is supplied from the Gate/Trigger generator circuit through CR15, R63, R65 to pin 1 of Z5A. Pin 2 of Z5A is simultaneously supplied with a +15v gate voltage so that Z5A pin 3 will drop from high (+15v) to low (0) when C9 is pulsed. The resulting pulse on Z5A pin 3 turns on Q10 which turns on the Control Voltage Memory (1st Voice/Memory Control) via CR6, and the 2nd Voice Memory (2nd Voice Memory Control) through CR16 and CR3.

When the Portamento Switch (S4) is turned on, pin 6 of Z5B is held high (+15v) by R66. Pin 5 of Z5B is supplied with the keyboard gate signal so that pin 4 of Z5B will be low which holds Q10 on continuously during a key depression. This is to enable Q4 in the Control Voltage Memory circuit to be on so that the memory capacitor has time to assume the correct voltage with the portamento control (R21) in the circuit. The voltage from R66 is also supplied through CR17 to reverse bias CR16 when the portamento is on to continuously gate the Second Voice Memory circuit. Board pins 16 and 17 are connected to the portamento foot switch jack and momentary push button. These switches are in series and are normally conducting.

## 2.8 LOW FREQUENCY OSCILLATOR

The LFO produces a triangle and a square wave output in a frequency range from about .1 Hz to 25 Hz. Z6B and C10 are an integrator which charges from current passing through R77. Z6A is a hysteretic switch whose output switches from -15 volts to +15 volts when the output of Z6B reaches +5 volts. This then reverses the direction of current through R77 and the rate control (R79) and thus the direction of integration at the output of Z6B. When the output of Z6B reaches -5 volts, the output of Z6A switches back to -15 volts and the cycle repeats. An LFO reset pulse is supplied from the ADSR circuit every time a key is depressed. Q11 is turned on momentarily by the LFO reset pulse and discharges the integrating capacitor (C10) thus resetting the LFO output to zero. CR18 clips the negative portion of the square wave and R81 and R82 voltage divide the square wave to +10 VPP.

## 2.9 VIBRATO DELAY & WAVE SHAPING

CR20 and CR21 clip the peaks of the triangle wave from the LFO (Z6B pin 7) to produce a 'sine' wave. When no keys are depressed, -15 volts from Keyboard Gate 2 is supplied to CR19 which turns Q12 on. Q13 is turned off and capacitor C11 is charged by the voltage from R83 (vibrato delay slider).

When a key is depressed, +15 volts is supplied to the gate of Q12 via CR19 which turns it off. Capacitor C11 can now be charged by the LFO sine wave to turn on Q13 gradually. The more negative the voltage supplied by R83 through Q12, the longer C11 takes to charge, thereby controlling the delay time. Z4B buffers the delayed sine wave which is then supplied to the Master Summation Circuit via the Ext. Vibrato input jack on the front panel.

## SECTION 3 TRIMS & ADJUSTMENTS

### INITIAL SETTINGS

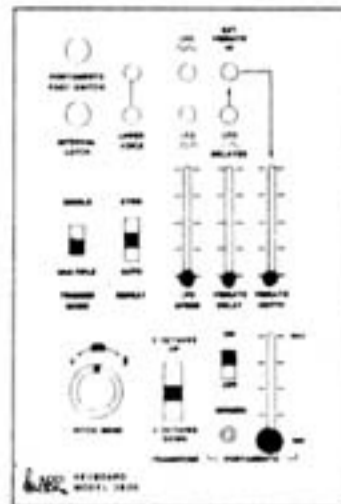

1. Portamento Slide Switch: on.
2. All Sliders: Fully Down
3. Trigger Mode: Multiple
4. Repeat Switch: Midposition (off)
5. Transpose Switch: Midposition
6. Pitch Bend: Centered



**CAUTION:** The trims and adjustments for the 3620 must be performed in the sequence presented for proper results.

REF. NO.	TRIMMER	TRIM PROCEDURE
R38	CV1 OFFSET	<ol style="list-style-type: none"> <li>1. Set controls to initial setting positions.</li> <li>2. Monitor the CV output on the 2600 panel (near multiple jacks) with a digital voltmeter.</li> <li>3. Pin low 'C' on the keyboard.</li> <li>4. Adjust trimmer R38 for 0.00 volts <math>\pm .5\text{mv}</math>.</li> </ol>
R39	CV1 V/OCT	<ol style="list-style-type: none"> <li>1. Set controls to initial setting positions.</li> <li>2. Pin high 'C' on the keyboard.</li> <li>3. Monitor the CV output on the 2600 panel with a digital voltmeter.</li> <li>4. Adjust trimmer R39 for +4.00 volts <math>\pm .5\text{mv}</math>.</li> </ol>
R30	PITCH BEND CALIBRATE	<ol style="list-style-type: none"> <li>1. Set controls to initial setting positions.</li> <li>2. Put the Pitch Bend control fully clockwise. Pin low 'C'.</li> <li>3. Monitor the CV output on the 2600 panel with a digital voltmeter.</li> <li>4. Adjust trimmer R30 for +1.00 volts <math>\pm .5\text{mv}</math>.</li> </ol>
R34	TRANSPOSE CALIBRATE	<ol style="list-style-type: none"> <li>1. Set controls to initial setting positions.</li> <li>2. Put the Transpose switch in the up 2 octaves position. Pin low 'C'.</li> <li>3. Monitor the CV output on the 2600 panel with a digital voltmeter.</li> <li>4. Adjust trimmer R34 for +2.00 volts <math>\pm .5\text{mv}</math>.</li> </ol>
R8	UPPER VOICE (CV-2) OFFSET	<ol style="list-style-type: none"> <li>1. Set controls to initial setting positions.</li> <li>2. Pin low 'C' and high 'C' on the keyboard.</li> <li>3. Monitor the Upper Voice CV output (on 3620 control panel) with a digital voltmeter.</li> <li>4. Adjust R8 for +4.00 volts <math>\pm .5\text{mv}</math>.</li> </ol>
R11	INTERVAL V/OCT	<ol style="list-style-type: none"> <li>1. Set controls to initial setting positions.</li> <li>2. Pin low 'C' on the keyboard.</li> <li>3. Monitor the Upper Voice CV output (on 3620 control panel) with a digital voltmeter.</li> <li>4. Adjust trimmer R11 for 0.00 volts <math>\pm .5\text{mv}</math>.</li> </ol>
R13	UPPER VOICE V/OCT	<ol style="list-style-type: none"> <li>1. Set controls to initial setting positions.</li> <li>2. Pin high 'C' on the keyboard.</li> <li>3. Monitor the Upper Voice CV output (on 3620 control panel) with a digital voltmeter.</li> <li>4. Adjust trimmer R13 for +4.00 volts <math>\pm .5\text{mv}</math>.</li> </ol>

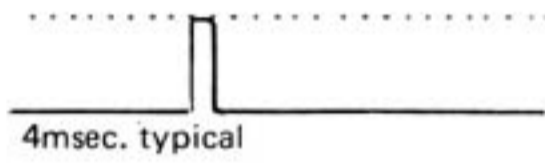
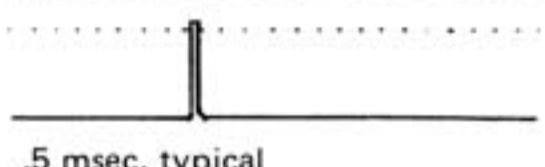
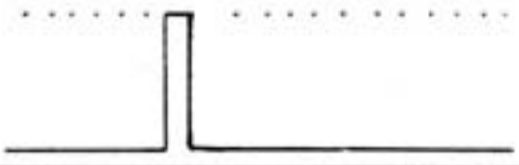
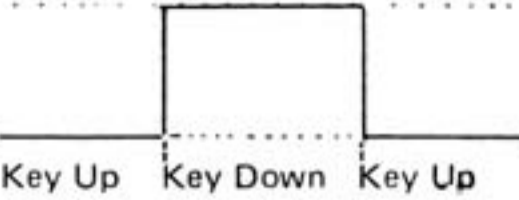
**BOARD TEST POINTS SECTION 4**

TEST POINT	FUNCTION	SET UP	SPECIFICATIONS
TP-1	KYBD CURRENT SOURCE	1. No keys depressed 2. High 'C' and low 'C' depressed	+4.0 volts 0.0 volts
TP-2	2ND VOICE MEMORY	1. Portamento Slide Switch: OFF 2. Depress and release any key. 3. Depress high 'C' and low 'C', then release both keys.	+4.0 volts 0.0 volts
TP-3	UPPER VOICE SUMMATION	1. Portamento Slide Switch: OFF 2. Transpose Switch: MIDPOSITION 3. Pitch Bend Control: CENTERED 4. Depress and release low 'C' 5. Depress and release high 'C'	0.0 volts +4.0 volts
TP-4	LOWER VOICE INVERTER	(SAME AS TP-3)	
TP-5	CV MEMORY	1. Portamento Slide Switch: OFF 2. Depress and release low 'C' 3. Depress and release high 'C'	0 volts + .1 volt Exactly 4 volts higher than low 'C' voltage
TP-6	MASTER SUMMATION	1. Portamento Slide Switch: OFF 2. Transpose Switch: MIDPOSITION 3. Pitch Bend Control: CENTERED 4. Depress and release low 'C' 5. Depress and release high 'C'	0.0 volts -4.0 volts
TP-7	KEYBOARD GATE 1	1. All keys up 2. Any key down	0 volts +15 volts
TP-8	KEYBOARD GATE GATE 2	1. All keys up 2. Any key down	-15 volts +15 volts
TP-9	MEMORY TRIGGER TRIGGER	1. Depress any key	 +15V 0 4msec. typical
TP-10	TRIGGER OUTPUT	1. Depress any key	 +12V 0 .5 msec. typical
TP-11	GATE OUTPUT	1. All keys up 2. Depress and hold any key	0 volts +10 volts
TP-12	1st VOICE MEMORY CONTROL	1. Portamento Slide Switch: OFF (Depress a key)	 +15V -14V
		2. Portamento Switch : ON (Depress a key)	 +15V -14V Key Up Key Down Key Up
TP-13	2nd VOICE MEMORY CONTROL	1. Portamento Slide Switch: ON: (Depress a key)	 +14 0V
		2. Portamento Slide Switch: OFF (Depress a key)	 +14V -10V

TEST POINTS CONTINUED

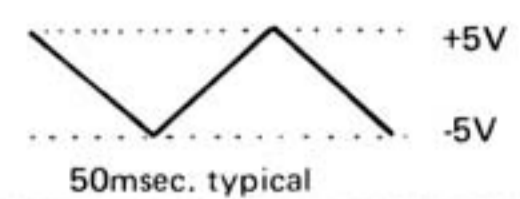
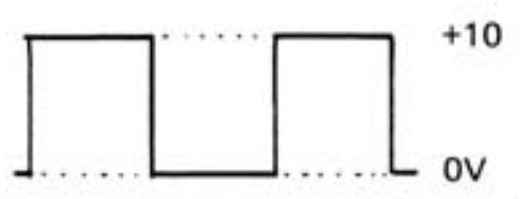
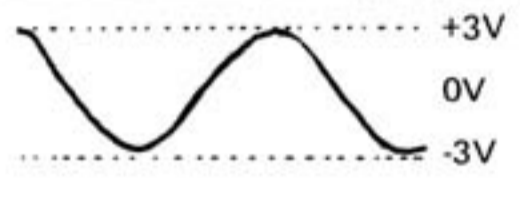
TEST POINT	FUNCTION	SET UP	SPECIFICATIONS
TP-14	LFO TRIANGLE OUTPUT	1. LFO Speed Slider: Up fully	 +5V -5V 50msec. typical
TP-15	LFO SQUAREWAVE OUTPUT	1. LFO Speed Slider: Up fully	 +10 0V
TP-16	DELAYED VIBRATO OUTPUT	1. LFO Speed Slider: Up fully 2. Vibrato Delay Slider: Down Fully	 +3V 0V -3V

SECTION 5 3620 THREE BUS CONVERSION BOARD

The 3620 electronics is designed to be used with a two bus keyboard. When the 3620 panel electronics is used with a three bus keyboard, an interface board is inserted on the mox pins of the 3620 electronics to make the keyboard compatible with the 3620.

When the 3620 is used with a three bus keyboard, the gate voltage from the bus is 0 volts with no keys de-

pressed and +15 volts when any keys are depressed. The trigger function is totally separate from the gate.

Q2 converts the gate from three bus keyboards to +15 volts with no keys depressed and +10 volts with any keys depressed. Q3 and Q4 add the trigger pulse to the gate voltage which is then supplied to the 3620 electronics.

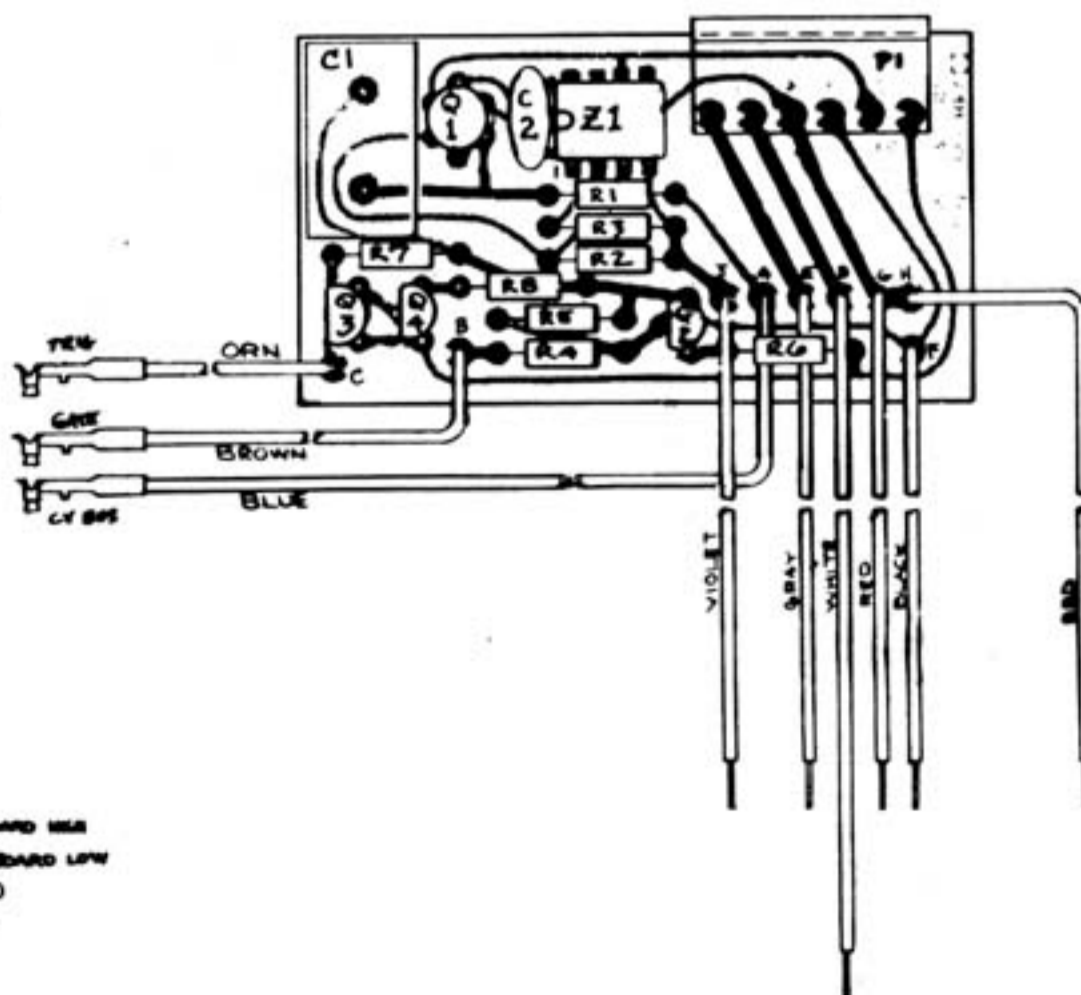
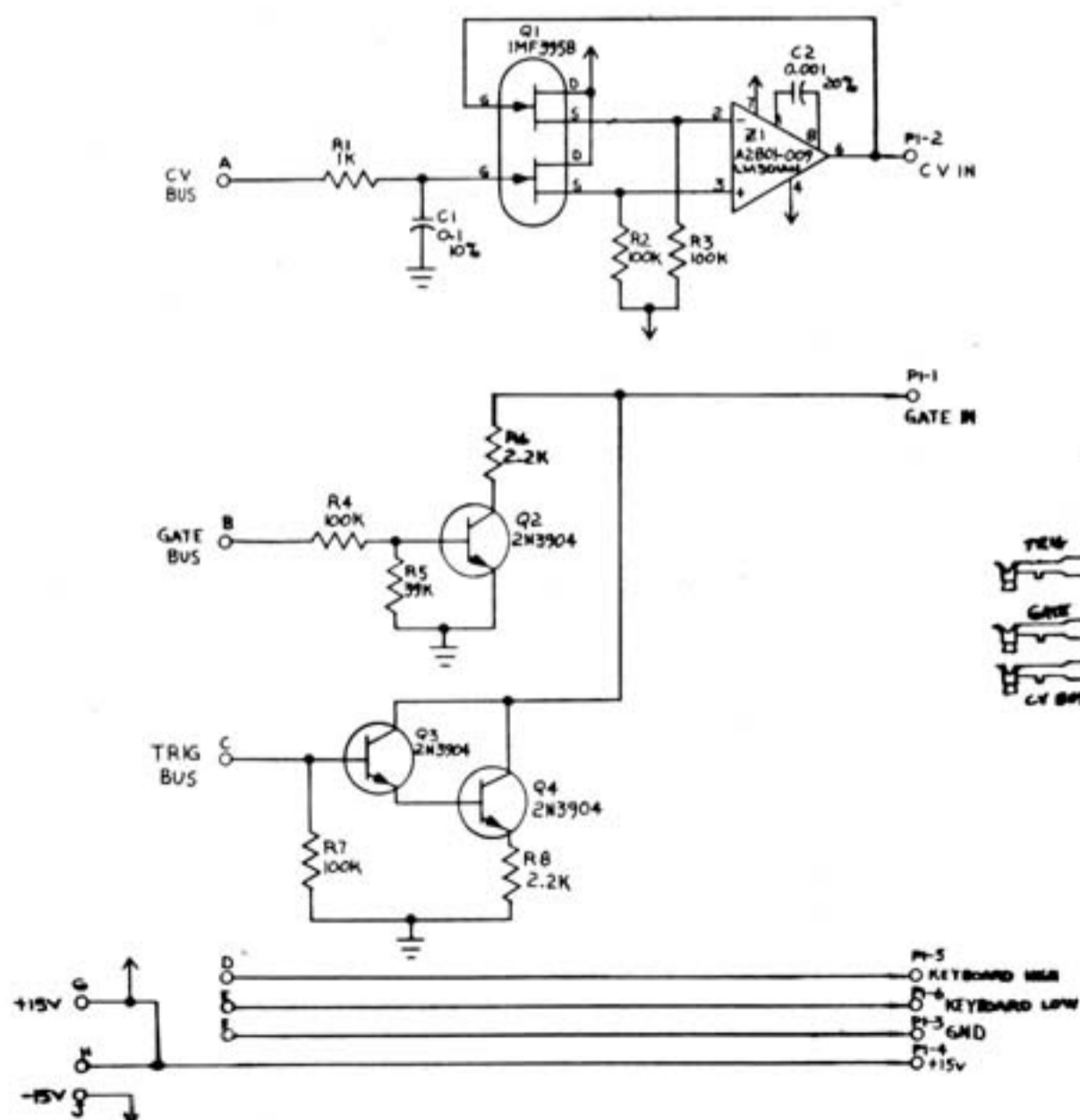



### 6.1 TYPES OF CONTACTS

Two types of keyboards have been employed in the 3620 keyboard. The new, two bus keyboard, contains a gate and control voltage bus; the older, three bus keyboard, has a gate, trigger and control voltage bus. The trigger function for the newer keyboard is generated in the 3620 circuitry.

It is important, for both types of keyboards, that the contacts be clean and properly adjusted. Since the upper and lower control voltages are memorized by a pulse signal instead of a gate, the contacts must be clean in order to provide correct voltages to the memory circuits. Should the control voltage bus become dirty or corroded, improper pitches, or sour notes, may occur from time to time due to the memorization of incorrect voltages.

### 6.2 CLEANING

Before any contact adjustments are undertaken, the bus and contacts should be cleaned. Use a 'Q' tip and

denatured alcohol or trichlorethelene. Be sure not to expose the keys and stand off mountings to any solvent unsafe for plastic.

### 6.3 CONTACT ADJUSTMENT

The design of the 3620 requires that the control voltage contact meet the bus slightly before the gate/trigger bus. This is to insure that the memory circuits are provided with the voltage which is to be memorized by the time the memory command signal from the gate/trigger bus occurs. The following two charts outline typical problems that may occur when the contacts are not adjusted properly.

*Do not make any contact adjustments until they have been cleaned; many problems which seem to be related to contact timing are actually caused by dirt.*

*NOTE: See section 5.4 of the 2600 Service Manual for contact adjustment procedure.*

#### THREE BUS KEYBOARDS

PROBLEM:	CAUSE:
Previous pitch heard before correct pitch on key depression	CV contact meeting bus too late (or Gate too soon)
Envelope is triggered twice on one key depression.	Trigger contact meeting bus too late.

#### TWO BUS KEYBOARDS

PROBLEM:	CAUSE:
Previous pitch or incorrect pitch memorized on key depression.	CV contact meeting bus too late (or Gate too soon) <i>Clean contacts before adjusting!</i>

## ASSEMBLY/DISASSEMBLY SECTION 7

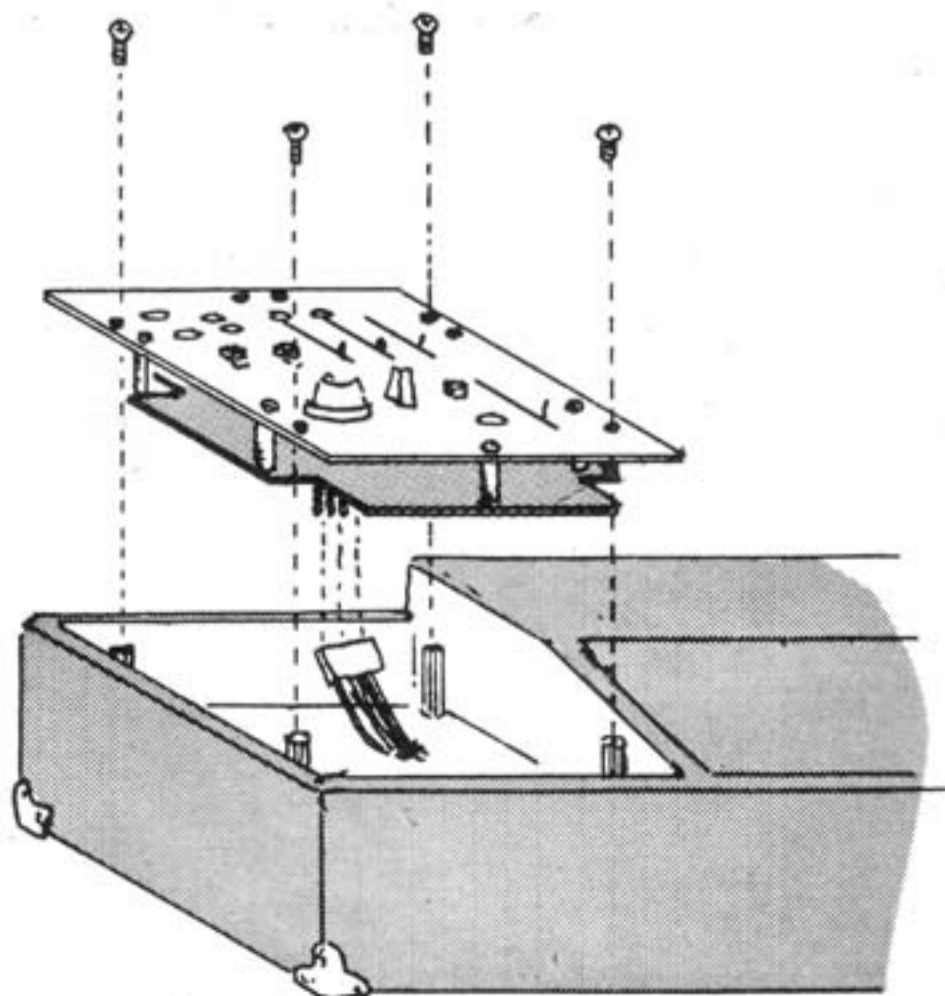

DO NOT REMOVE THESE SCREWS

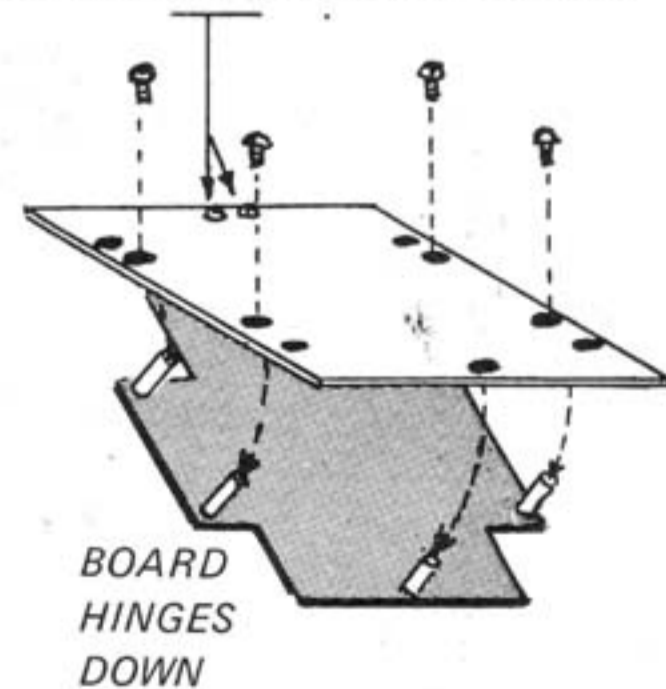

- TP-3: UPPER VOICE OUTPUT JACK
- TP-4: CV OUTPUT JACK ON 2600
- TP-10: TRIGGER OUTPUT JACK ON 2600
- TP-11: GATE OUTPUT JACK ON 2600
- TP-14: LFO TRIANGLE OUTPUT JACK
- TP-15: LFO SQUARE WAVE OUTPUT JACK

FOIL SIDE VIEW

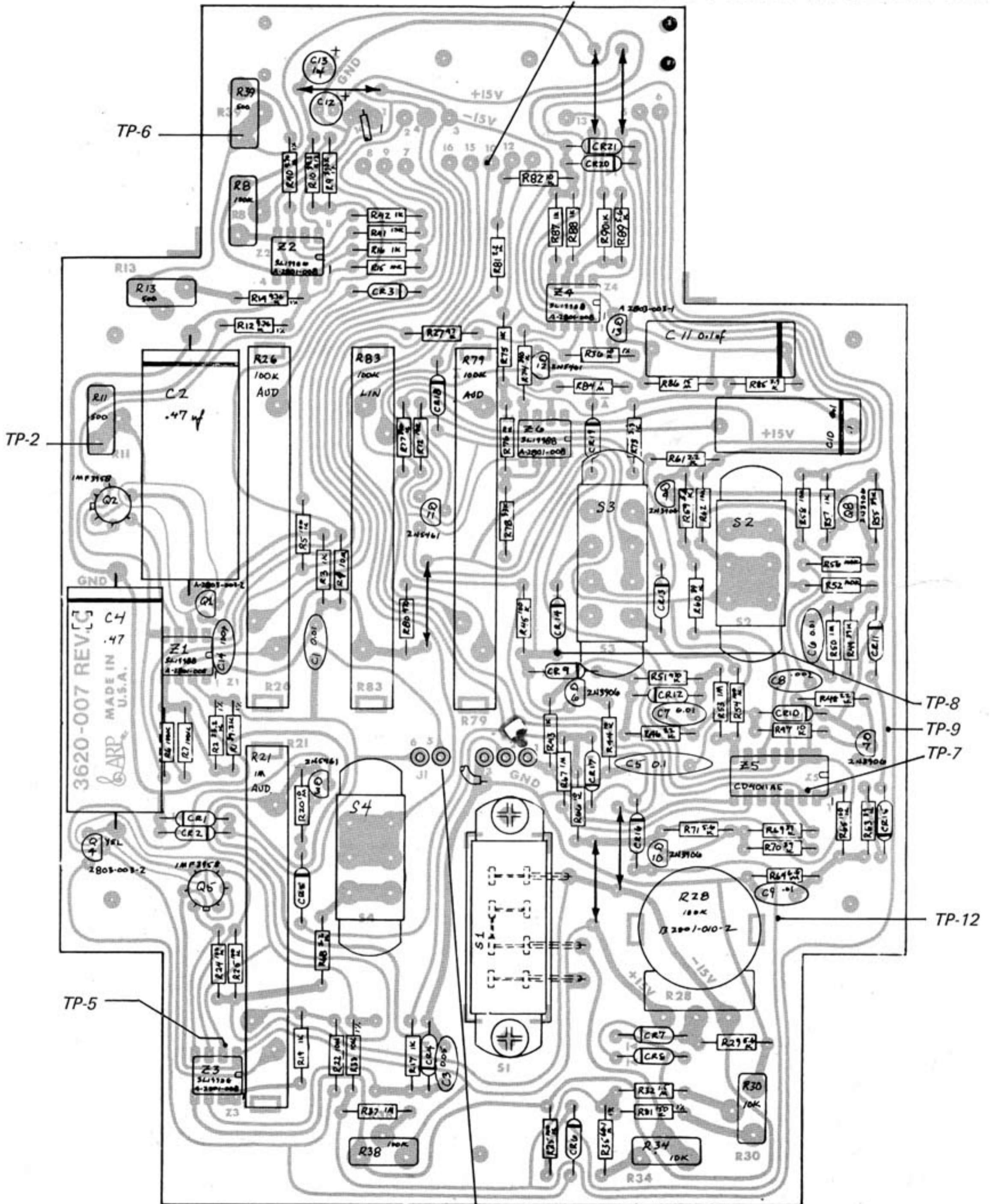

FOIL SIDE VIEW

TP-1

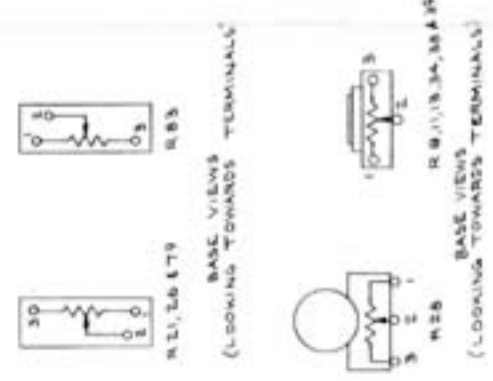
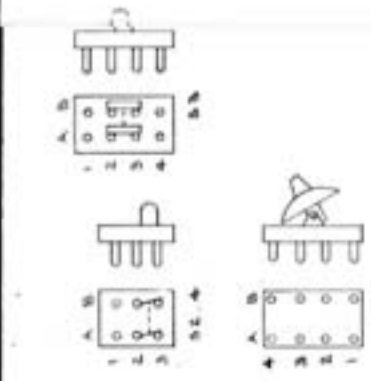

NOTES:  
 1. UNLESS OTHERWISE SPECIFIED, ALL RESISTOR VALUES ARE IN OHMS, ALL CAPACITOR VALUES ARE IN PICOFARADS (P=PICOFARADS). ALL DIODES ARE 1N4148.  
 2. HIGHEST REF DES. C14, C22, J1, J15, R90, R4, R6, C14, C22, J1, J15, R90, R4, R6. CONVENTION USED FOR SUPPLY VOLTAGE CONNECTIONS:  
 ↑ IMPLIES +15V  
 ↓ IMPLIES -15V

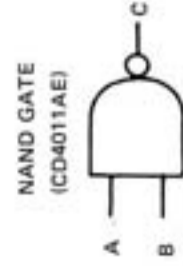

A	B	C
0	0	1
0	1	1
1	0	1
1	1	0

1 = > 7.5V  
 0 = < 7.5V

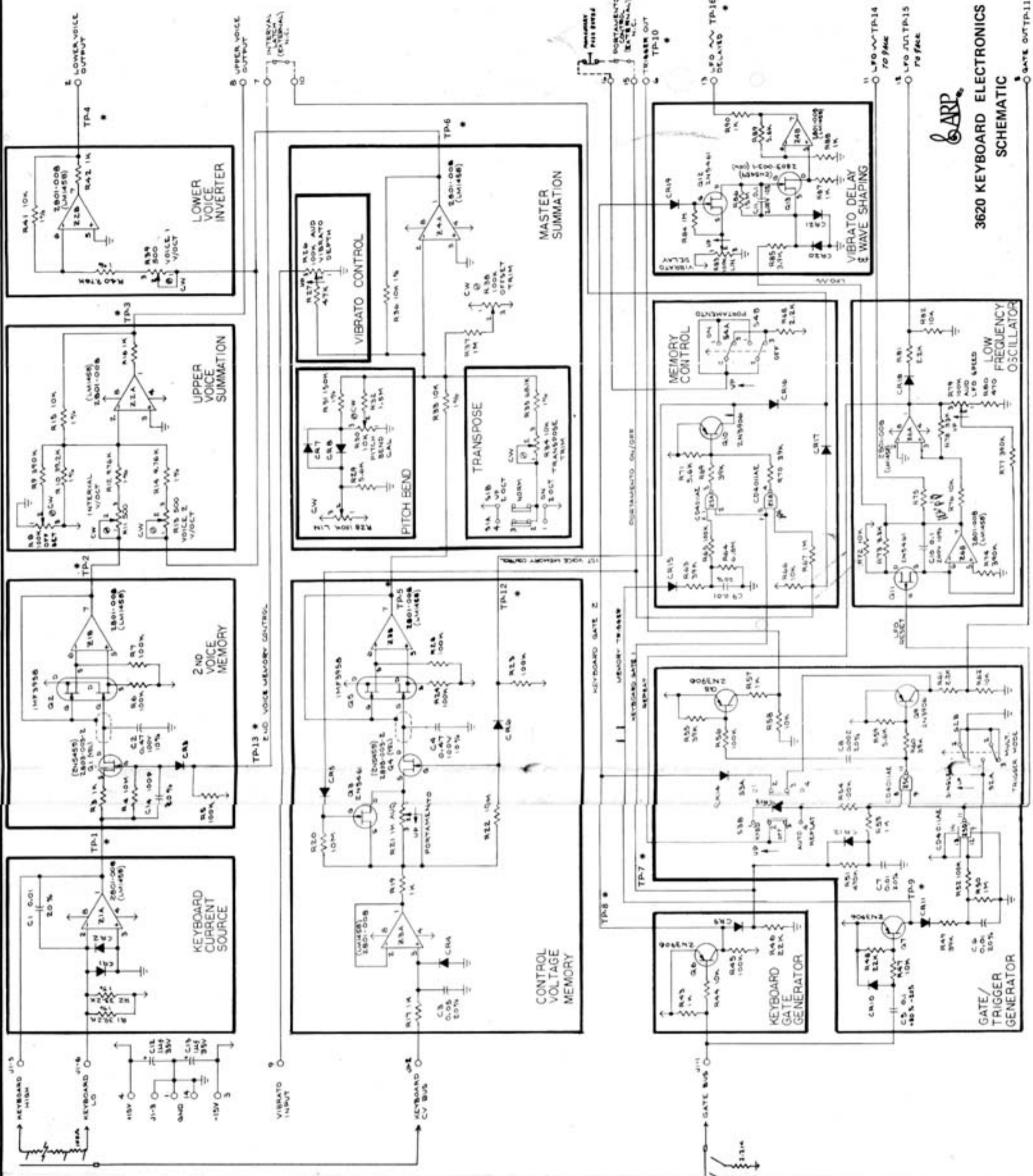
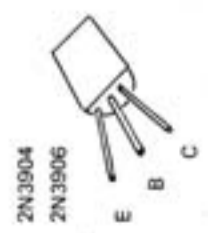

3620 KEYBOARD ELECTRONICS SCHEMATIC

REFERENCE	ARP PART NUMBER	ARP/MFG NUMBER	DESCRIPTION
CR1-21	1200301	2N4148	DIODE,SILICON,SIGNAL
Q6,7,8,9,10	1303001	2N3906	TRANSISTOR, SILICON, PNP
Q13	5600201	A2803-003-1	TRANSISTOR, FET SEL. 2N5459 (ORN)
Q1, 4	5600202	A2803-003-2	TRANSISTOR, FET, SEL, 2N5459 (YEL)
Q3, 11, 12	1302501	2N5461	TRANSISTOR, FET, P-CHANNEL
Q2, 5	1303901	IMF3958	TRANSISTOR, DUAL J-FET
Z1, 2, 3, 4, 6	5601801	A2801-008	AMP, OPL, TESTED LM1458
Z5	1400601	CD4011AE	GATE, QUAD 2IN. NAND CMOS
R79, 83, 26	5700702	B2801-006-2	POT., SLIDE, AUD., 1/3W, 30% 100K
R21	5700701	B2801-006-1	POT., SLIDE, AUD., 1/4W, 30%, 1M
R83	5700703	B2801-006-3	POT., SLIDE, LIN, 1/3W, 30%, 100K
C12, 13	1100609	G-0-001-G-20-0	CAP., TANT, 35V, 20% 1UF
C2, 4	1100901	WCR1P47	CAP., POLYCARB., 100V, 10%, 0.47UF
C10,11	1100205	2Ps-P10	CAP., POLYESTER, 200V, 10%, 0.1UF
S1	1900801	02-481-0001B	SWITCH, ROCKER, DP3T
S2, 4	1902401	01-481-0006A	SWITCH, SLIDE, DPDT
S3	1900601	01-481-0004A	SWITCH, SLIDE, DP3T



# FIELD CHANGE NOTICE

MODEL: 3620

DATE: 12-16-75

EFFECTIVITY: ANY 3620 WITH DRIFT PROBLEMS  
EST. TIME TO COMPLETE: ½ Hour

*FCN 005*

*REASON FOR CHANGE:* To reduce control voltage drift by the use of 2N4392 (or LS 4392) FETs instead of 2N5459.

*MATERIAL REQUIRED:* (2) 2N4392 (or LS4392)

*PARTS DISPOSITION:* Order FCN-005

*DETAILS OF CHANGE:* Change Q1 and Q4 in the memory circuits from 2N5459 to 2N4392 (or LS4392).

*DOCUMENTS AFFECTED:* 3620 Service Manual (document number 9000400), pages 10 and 11.