



MIDI SYNTHESIZER MODULE

MKS-50

Owner's Manual





The lightning flash with arrowhead symbol, within an equilateral triangle, is intended to alert the user to the presence of un-insulated "dangerous voltage" within the product's enclosure that may be of sufficient magnitude to constitute a risk of electric shock to persons.



The exclamation point within an equilateral triangle is intended to alert the user to the presence of important operating and maintenance (servicing) instructions in the literature accompanying the product.

INSTRUCTIONS PERTAINING TO A RISK OF FIRE, ELECTRIC SHOCK OR INJURY TO PERSONS.

IMPORTANT SAFETY INSTRUCTIONS

WARNING When using electric products, basic precautions should always be followed, including the following:

1. Read all the instructions before using the product.
2. To reduce the risk of injury, close supervision is necessary when a product is used near children.
3. Do not use this product near water—for example, near a bathtub, washbowl, kitchen sink, in a wet basement, or near a swimming pool, or the like.
4. This product should be used only with a cart or stand that is recommended by the manufacturer.
5. This product, either alone or in combination with an amplifier and headphones or speakers, may be capable of producing sound levels that could cause permanent hearing loss. Do not operate for a long period of time at a high volume level or at level that is uncomfortable. If you experience any hearing loss or ringing in the ears, you should consult an audiologist.
6. The product should be located so that its location or position does not interfere with its proper ventilation.
7. The product should be located away from heat sources such as radiators, heat registers or other products that produce heat.
8. The product should avoid using in where it may be effected by dust.
9. The product should be connected to a power supply only of the type described in the operating instructions or as marked on the product.

10. The power-supply cord of the product should be unplugged from the outlet when left unused for a long time.
11. Do not tread on the power-supply cord.
12. Do not pull the cord but hold the plug when unplugging.
13. When setting up with any other instruments, the procedure should be followed in accordance with instruction manual.
14. Care should be taken so that objects do not fall and liquids are not spilled into the enclosure through openings.
15. The product should be serviced by qualified service personnel when:
 - A: The power-supply cord or the plug has been damaged; or
 - B: Objects have fallen, or liquid has been spilled into the product; or
 - C: The product has been exposed to rain; or
 - D: The product does not appear to operate normally or exhibits a marked change in performance; or
 - E: The product has been dropped, or the enclosure damaged.
16. Do not attempt to service the product beyond that described in the user-maintenance instructions. All other servicing should be referred to qualified service personnel.

SAVE THESE INSTRUCTIONS

Bescheinigung des Herstellers/Importeurs

Hiermit wird bescheinigt, daß der/die/das

ROLAND SYNTHESIZER MODULE MKS-50

(Genr. Typ. Bezeichnung)

in Übereinstimmung mit den Bestimmungen der

Amtsbl. Vfg 1046 / 1984

(Anmeldeverfahren)

funk-entstört ist.

Der Deutschen Bundespost wurde das Inverkehrbringen dieses Gerätes angezeigt und die Berechtigung zur Überprüfung der Serie auf Einhaltung der Bestimmungen eingeräumt.

Roland Corporation Osaka / Japan

Name des Herstellers/Importeurs

RADIO AND TELEVISION INTERFERENCE

Warning - This equipment has been verified to comply with the limits for a Class B computing device, pursuant to Subpart J, of Part 15, of FCC rules. Operation with non-certified or non-verified equipment is likely to result in interference to radio and TV reception.

The equipment described in this manual generates and uses radio frequency energy. If it is not installed and used properly, that is, in strict accordance with our instructions, it may cause interference with radio and television reception.

This equipment has been tested and found to comply with the limits for a Class B computing device in accordance with the specifications in Subpart J, of Part 15, of FCC Rules. These rules are designed to provide reasonable protection against such interference in a residential installation. However, there is no guarantee that the interference will not occur in a particular installation. If this equipment does cause interference to radio or television reception, which can be determined by turning the equipment on and off, the user is encouraged to try to correct the interference by the following measure:

- Disconnect other devices and their multipoint cables one at a time. If the interference stops, it is caused by either the other device or its I/O cable.

These devices usually require Roland designated shielded I/O cables. For Roland devices, you can obtain the proper shielded cable from your dealer. For non-Roland devices, contact the manufacturer or dealer for assistance.

If your equipment does cause interference to radio or television reception, you can try to correct the interference by using one or more of the following measures:

- Turn the TV or radio antenna until the interference stops.
- Move the equipment to one side or the other of the TV or radio.
- Move the equipment farther away from the TV or radio.
- Plug the equipment into an outlet that is on a different circuit than the TV or radio. (That is, make certain the equipment and the radio or television set are on circuits controlled by different circuit breakers or fuses.)
- Consider installing a rooftop television antenna with coaxial cable lead-in between the antenna and TV.

If necessary, you should consult your dealer or an experienced radio/television technician for additional suggestions. You may find helpful the following booklet prepared by the Federal Communications Commission:

"How to Identify and Resolve Radio-TV Interference Problems"

This booklet is available from the U.S. Government Printing Office, Washington, D.C. 20402, Stock No. 004 000 00245-4

Please read the separate volume "MIDI", before reading this owner's manual.

Copyright © 1986 by ROLAND CORPORATION

All rights reserved. No part of this publication may be reproduced in any form without the written permission of ROLAND CORPORATION.

1 PANEL DESCRIPTION

<FRONT PANEL>

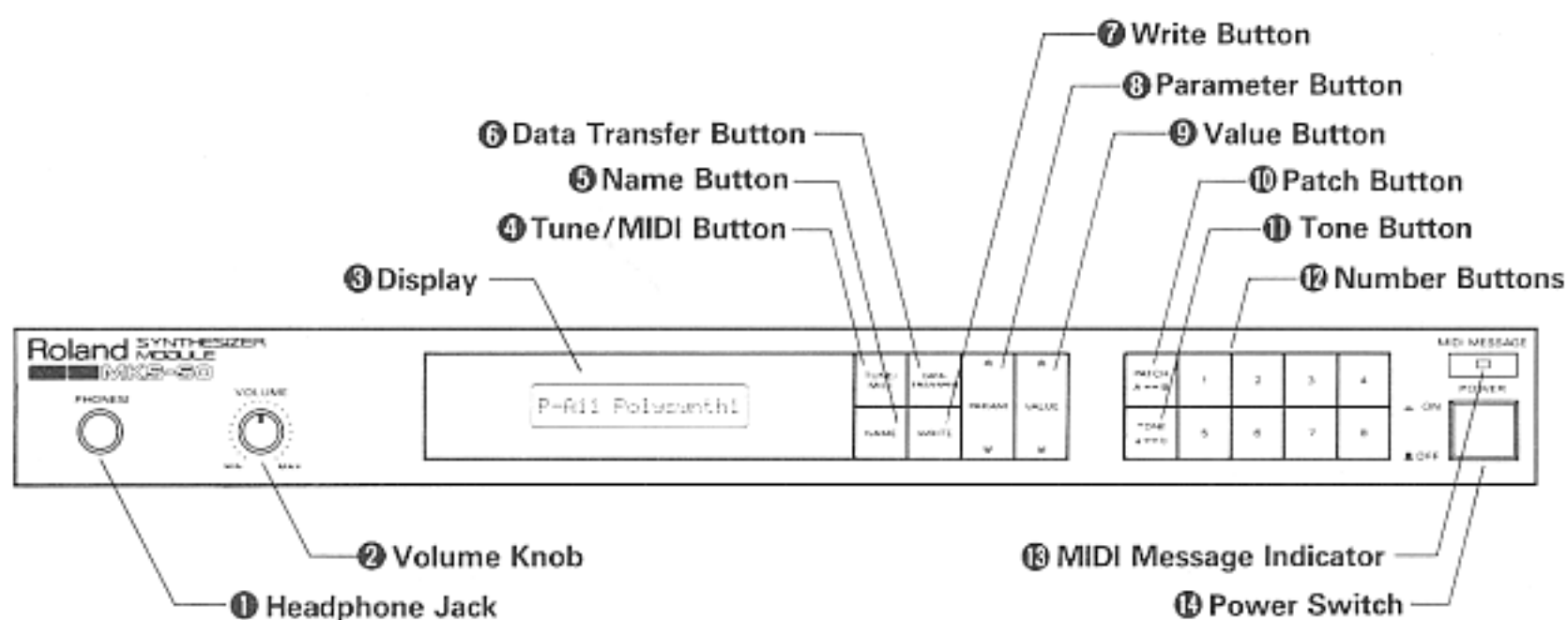

<REAR PANEL>

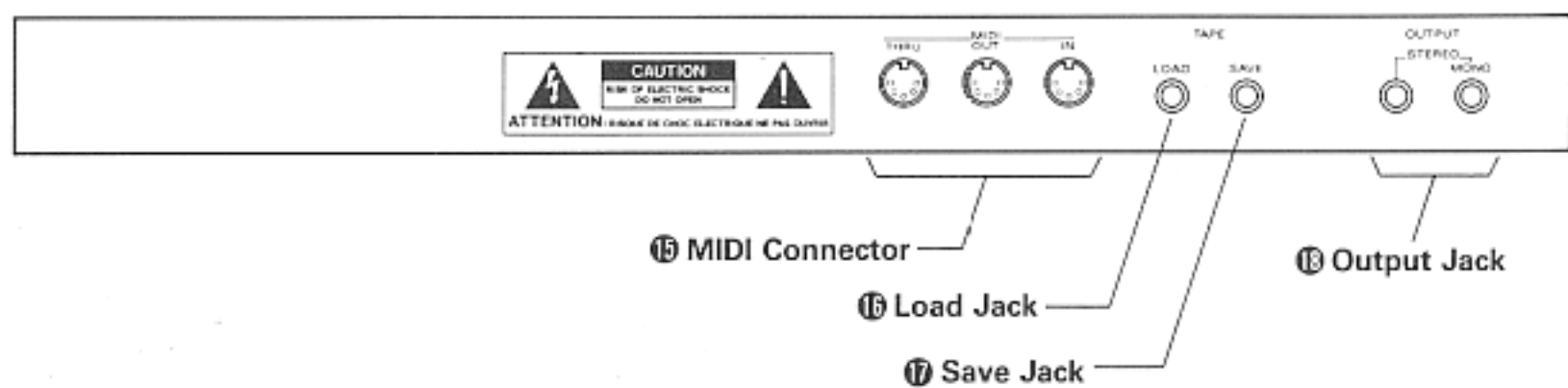

CONTENTS

1	Panel Description	3	2	Tone Editing	23
			a.	Editing Tone Parameters	23
2	Playing	6	b.	Tone Parameters	25
			c.	Writing a Tone	36
1	MKS-50 as a Sound Module of the MIDI Guitar System	6	3	Naming	37
a.	Connection	7	4	Other Functions	39
b.	Initialization	8	1	Chord Memory	39
c.	Power-up	8	2	Mode Selection	42
d.	MIDI Channel Setting	9	3	Data Transfer	44
e.	Tuning	9	a.	Saving on a Tape	44
f.	Patch Selection in the Internal Memory	10	b.	Bulk Dump/Bulk Load	49
g.	Patch Selection from the external device	11	c.	Transferring only a part of data	51
2	MKS-50 as a Sound Module of the Keyboard	12	5	Appendix Tables	52
a.	Connection	12	1	Patch Function Table	52
b.	Initialization	13	2	Tone Parameter Table	53
c.	Power-up	13	3	Error Message Table	56
d.	MIDI Channel Setting	14	4	Sample Note	57
e.	Tuning	15	5	Quick Operation Table	60
f.	Patch Selection in the Internal Memory	15	6	Specifications	67
g.	Patch Selection from the external device	16			
3	Editing	17			
1	Patch Editing	17			
a.	Changing Tone Numbers in a Patch	17			
b.	Changing Functions in a Patch	18			
c.	Writing a Patch	22			

FEATURES

- The Roland MKS-50 is fully programmable six voice polyphonic synthesizer sound module which can be controlled by the external MIDI device.
- The MIDI Mono Mode makes the MKS-50 extremely useful as the sound module for the MIDI Guitar System.
- The MKS-50 features the memory capacity that can store up to 128 different sounds (=Tones) and the 128 combinations of the Tones and the performance control functions (=Patches)
- The Chord Memory function allows to play any of the 16 chords you have programmed by playing only one key.

IMPORTANT NOTES

- The appropriate power supply for this unit is shown on its name plate. Please make sure that the line voltage in your country meets the requirement.
- Please do not use the same socket used for any noise generating device (such as motor, variable lighting system).
- This unit might not work properly if turned on immediately after turned off. If this happens, simply turn it off and turn it on again after waiting a few seconds.
- Before setting up this unit with other devices, turn this unit and all the other units off.
- It is normal for this unit to become warm while it is being operated.
- Use a soft cloth and clean only with a mild detergent.
- Do not use solvents such as paint thinner.
- Avoid using this unit in excessive heat or humidity or where it may be affected by direct sunlight or dust.
- Operating this unit near a neon, fluorescent lamp, TV or CRT Display may cause noise interference. If so, change the angle or the position of the unit.

★ MEMORY BACK-UP

- The MKS-50 features a memory back-up system that retains the data even when switched off. The battery that supports the back-up circuit should be replaced every five years. Call for the Roland service station for the battery replacement. (The first replacement may be required before five years, depending on how much time it had passed before you purchased the unit.)
- Please make a memo of the data or save it on to tape before having the MKS-50 repaired. There is no way for restoring the lost data.
- If the Display responds with as shown below, the data in memory may be erased.

Check Battery!!

2 PLAYING

The MKS-50 is the sound module that can be played with the MIDI signal sent from the external device. More than one MIDI message can be received by the MKS-50 using different MIDI Channels 1 to 16.

Also, the MKS-50 can select the Poly or Mono mode. The Poly mode allows to receive more than one MIDI message on one channel, and the Mono mode allows one MIDI message on one channel. In other words, the MKS-50 is 6 voice polyphonic module in the Poly Mode, and 6 monophonic's with 6 MIDI channels in the Mono mode.

The Poly or Mono mode should be correctly selected on the MKS-50 depending on the external MIDI device.

When using the MKS-50 as a sound module of the keyboard, sequencer or computer, refer to "MKS-50 as a Sound Module of the Keyboard (Poly Mode)" on page 12.

Some of the Roland's new model MIDI Guitar System features the MIDI Mono mode, but the previous type guitar synthesizers (eg. GR-700, GR-77B) can select only the Poly mode; refer to "MKS-50 as a Sound Module of the Keyboard (Poly Mode)" on page 12.

The MKS-50's Mono mode does not allow to set a different voice for each note separately. This is because each channel is not perfectly independent. The Note Message (e.g. pitch, volume) and the Bender message (guitar's chalking), however, are independent.

Please read "Mode Selection" on page 42.

1. THE MKS-50 AS A SOUND MODULE OF THE MIDI GUITAR SYSTEM (MONO MODE)

To obtain realistic guitar sound without spoiling its characteristic, the MKS-50 features the Mono Mode that allows to receive the signal from each string separately. To use the MKS-50 with the guitar system that provides an independent MIDI channel for each of the strings, read the following instructions.

a. Connection

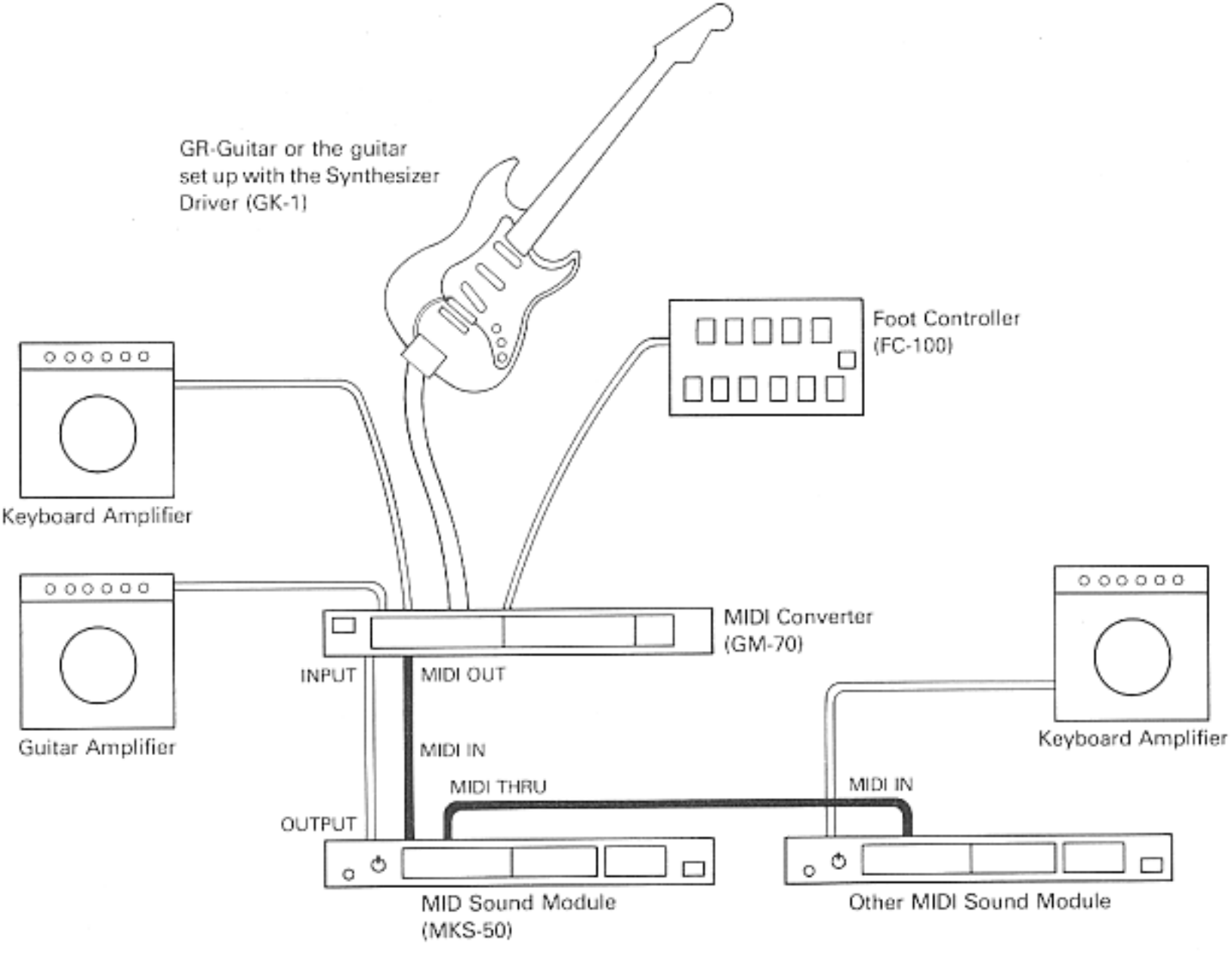

* The MIDI THRU Connector sends out the exact copy of the signal fed into the MIDI IN. This fact technically allows one MIDI device to control as many external MIDI devices. This, however, is not the case in practice. To connect more than three devices, use the optional MIDI THRU BOX MM-4 or MIDI Output Selector MPU-105.

* The signal fed into the MIDI IN is not sent out through the MIDI OUT.

b. Initialization

The basic setting needed for playing the system is preprogrammed in the MKS-50, but this program may have been changed.

To initialize the MKS-50, turn it on while holding the Number Buttons 3 and 7 down.

* Please note that initialization will erase all the current data, replacing it with the preprogrammed data.

Initialization is not needed from the second time you use the MKS-50.

Initializing the MKS-50 which has been used as a usual polyphonic sound module will turn all the Patches to the Mono mode settings.

c. Power-up

First of all, make sure that the MKS-50 is correctly set up with the external device.

- ① Turn the MKS-50 on.

The Display changes as below:



- ② Turn the external MIDI device on.
- ③ Turn the amplifier on.

d. MIDI Channel Setting

The MIDI channels of the connected units should be set to the same number. Unless the MKS-50's receive MIDI channel is set correctly, the necessary MIDI messages cannot be received, therefore the MKS-50 cannot be played properly.

- ① Push the Tune/MIDI Button ④.
- ② Push the Parameter Button ⑧ until "MIDI Channel" is shown in the Display.

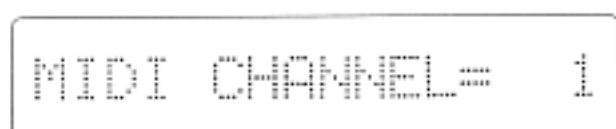

MIDI CHANNEL= 1

- ③ Using the Value Button ⑨, select the MIDI channel number you want.

The Roland MIDI-Guitar Converter is designed to transmit MIDI signal to each string separately; the MIDI channel you set is assigned to the 1st string, that plus one to the 2nd string, that plus two to the 3rd string, and so on. For instance, if you set the MIDI channel 2, channel 2 is assigned to the first string, channel 3 to the second string, channel 4 to the third string and so on up to the channel 7 to the sixth string.

* In the MIDI Mono mode, do not select the MIDI channel higher than 12. This is because it would make the MIDI channel higher than 16 which cannot be used therefore would mute the string.

* The MIDI channel you set is retained in memory even after the MKS-50 is turned off.

e. Tuning

The MKS-50 is played in the pitch of the MIDI signal sent from the guitar, therefore sounds in A4=442Hz standard pitch if the guitar is rightly tuned. If necessary, you can tune the MKS-50 to the guitar.

- ① Push the Tune/MIDI Button ④.



TUNE ▶ 442 ◀

- ② Play the guitar, and push the Value Button ⑨ until the MKS-50 is tuned to the guitar.

Pushing the upper side of the Value Button increases the pitch and the lower side decreases.

The number shown in the Display represents the frequency of the standard pitch (A4). It changes in 1Hz step, but actually changes almost continuously (in 0.4 cent steps).

The ▶ and ◀ shown on the both sides of the number represent as follows:

- 1) When ▶ is shown, the actual pitch is slightly lower than the value shown in the Display.
- 2) When ◀ is shown, the actual pitch is slightly higher than the value shown in the display.
- 3) When both ▶ and ◀ are shown, the value shown in the Display is almost equal to the actual pitch.

* The value you set is retained in memory even when the MKS-50 is switched off.

f. Patch Selection in the Internal Memory

A Patch consists of a Tone and the performance control functions. The MKS-50 can retain up to 128 different Tones and 128 different Patches, and you can select any of the Patches simply by pushing the relevant buttons.

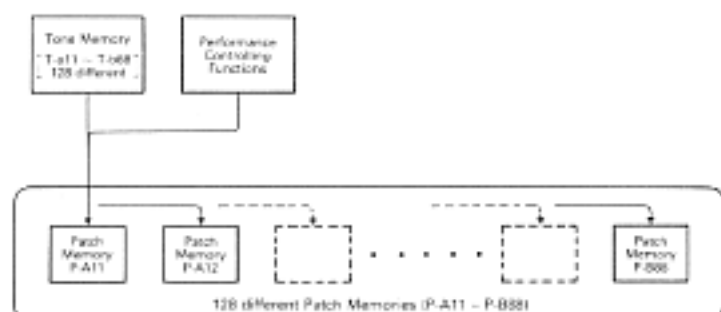

As shown in the picture below, Patches are divided into two Groups A and B, and each Group contains 8 Banks and 8 Numbers.

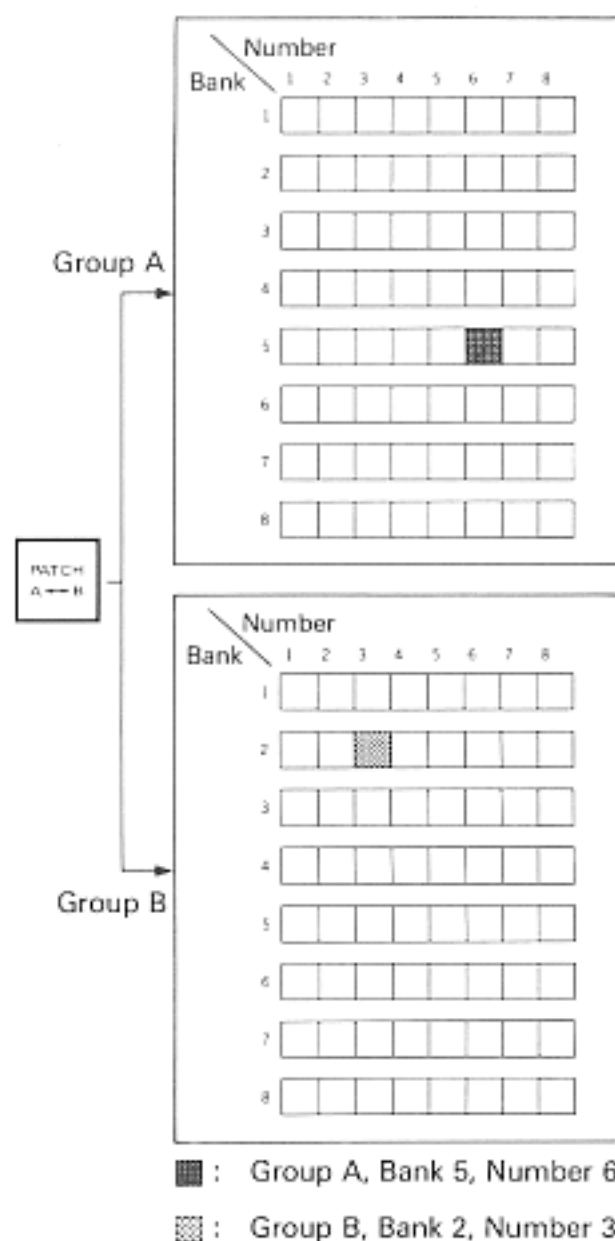

The Display shows the Patch in the combination of an alphabet and a number such as A56, B23 etc.

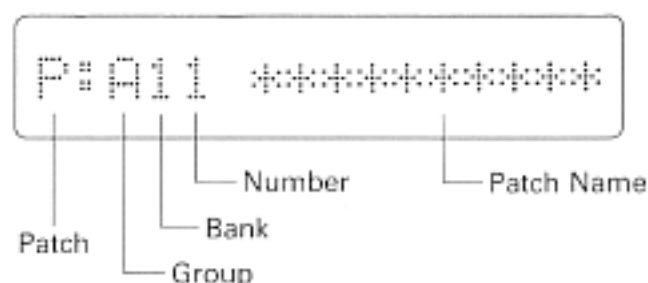

How to select a Patch

- ① Push the Patch Button ⑩ to select the Group A or B

Each time the Patch Button is pushed, the Group A and B are alternately selected.

- ② Select the Bank (1 to 8) and the Number (1 to 8) by using the Number Buttons 12.

First, select the Bank, and the Number area in the Display flashes. Then select the Number.

* Either of the above procedures ① and ② can be taken first.

- ▶ While a Patch is shown in the Display (= the Display shows as above), the Patch can be heard by pushing the upper side of the Value Button ⑨.

g. Patch Selection from the External Device

By sending the Program Change messages from the external MIDI device, the Patches on the MKS-50 can be changed.

The Program Change numbers correspond to the Patch Numbers as shown in the following table.

	BANK ^{NO}	1	2	3	4	5	6	7	8
A	1	1	2	3	4	5	6	7	8
	2	9	10	11	12	13	14	15	16
	3	17	18	19	20	21	22	23	24
	4	25	26	27	28	29	30	31	32
	5	33	34	35	36	37	38	39	40
	6	41	42	43	44	45	46	47	48
	7	49	50	51	52	53	54	55	56
	8	57	58	59	60	61	62	63	64
B	1	65	66	67	68	69	70	71	72
	2	73	74	75	76	77	78	79	80
	3	81	82	83	84	85	86	87	88
	4	89	90	91	92	93	94	95	96
	5	97	98	99	100	101	102	103	104
	6	105	106	107	108	109	110	111	112
	7	113	114	115	116	117	118	119	120
	8	121	122	123	124	125	126	127	128

*Number 0 to 127 are used as Program Change Messages in the actual MIDI Format.

You can set the MKS-50 to ignore the Program Change messages:

- ① Push the Tune/MIDI Button ④.
- ② Select "Program Change" by using the Parameter Button ⑧.

MIDI PROG. CG= ON

- ③ Select "OFF" with the Value Button ⑨.

2. MKS-50 AS A SOUND MODULE OF THE KEYBOARD (POLY MODE)

To use the MKS-50 as a usual polyphonic sound module for the MIDI keyboard, sequencer etc, read the following instructions.

a. Connection

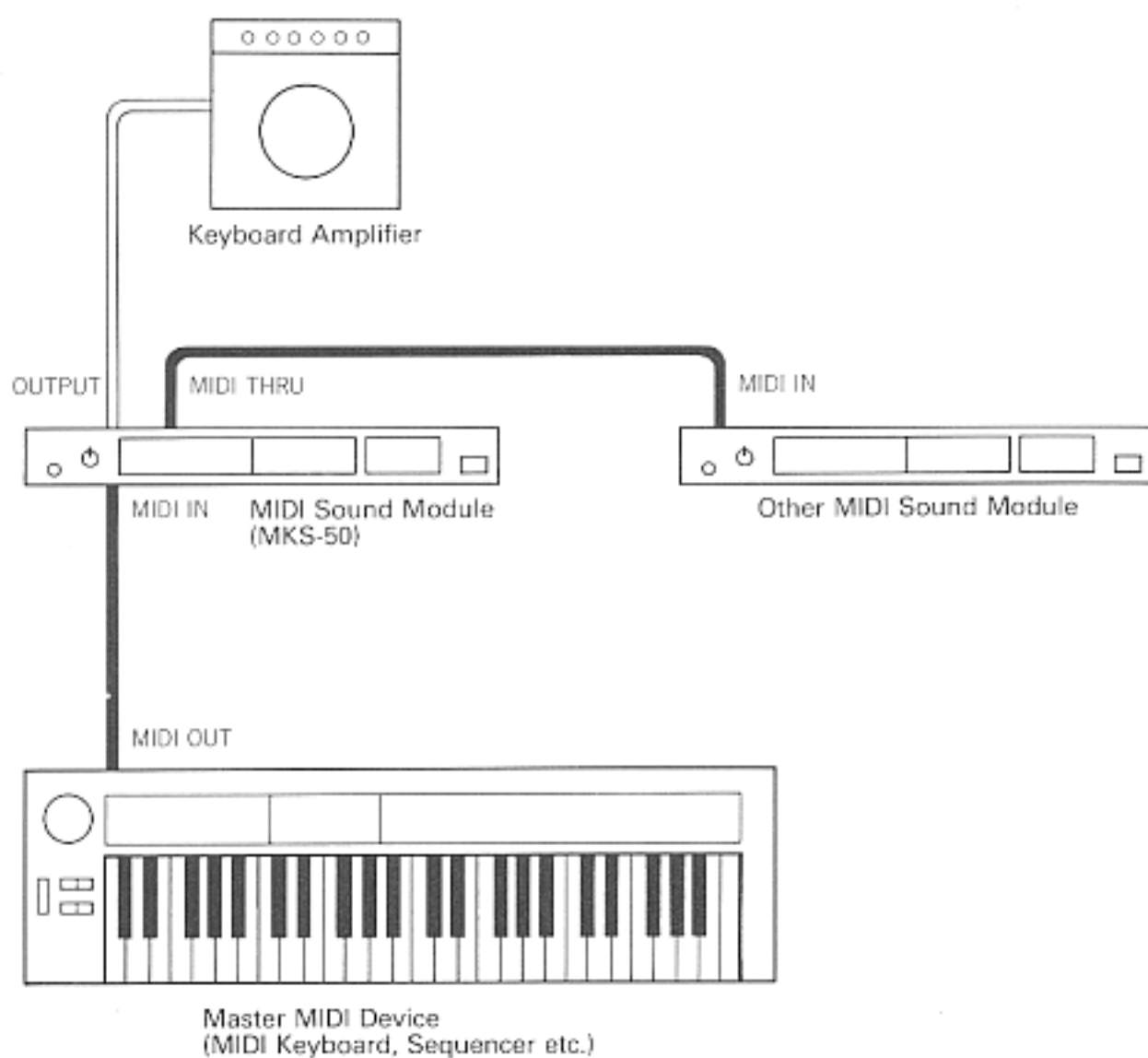

* The **MIDI THRU** Connector sends out the exact copy of the signal fed into the **MIDI IN**. This fact technically allows one **MIDI** device to control as many external **MIDI** devices. This, however, is not the case in practice. To connect more than three devices, use the optional **MID THRU BOX MM-4** or **MIDI Output Selector MPU-105**.

* The signal fed into the **MIDI IN** is not sent out through the **MIDI OUT**.

d. MIDI Channel Setting

The MIDI channels of the connected units should be set to the same number. Unless the MKS-50's receive MIDI channel is set correctly, the necessary MIDI messages cannot be received, therefore the MKS-50 cannot be played properly.

- ① Push the Tune/MIDI Button ④.
- ② Push the Parameter Button ③, until the Display shows "MIDI Channel".

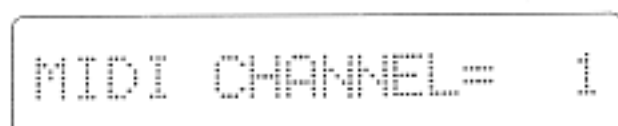

MIDI CHANNEL= 1

- ③ Using the Value Button ⑨, select the MIDI channel number you want.

Usually, the MIDI keyboard is polyphonic that allows to play more than one notes at the same time. This is called Poly Mode.

* The MIDI channel you set is retained in memory even after the MKS-50 is turned off.

«How to turn the MKS-50 to the OMNI ON mode»

OMNI ON is the mode that allows to receive data on all the channels regardless of the set receive channel.

- ① Push the Tune/MIDI Button ④.
- ② Select "OMNI" by using the Parameter Button ③.

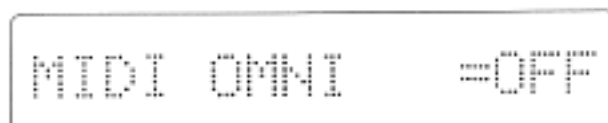

MIDI OMNI =OFF

- ③ Select "ON" with the Value Button ⑨.

* The OMNI Mode you have set is retained in memory even when the unit is turned off.

e. Tuning

The MKS-50 is played in the pitch of the MIDI signal sent from the external instrument, therefore sounds in A4=442Hz standard pitch if the external instrument is rightly tuned. If necessary, you can tune the MKS-50 to the external device.

- 1) Push the Tune/MIDI Button **4**.

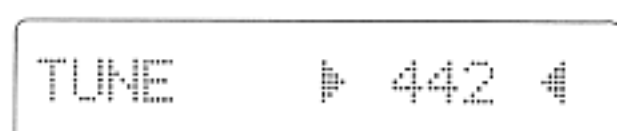

- 2) Play the MKS-50 together with the external instrument, and push the Value Button **9** until the MKS-50 is tuned to the instrument.

Pushing the upper side of the Value Button increases the pitch and the lower side decreases.

The number shown in the Display represents the frequency of the standard pitch (A4). It changes in 1Hz step, but actually changes almost continuously (in 0.4 cent steps).

The **▶** and **◀** shown on the both sides of the number represents as follows:

- 1) When **▶** is shown, the actual pitch is slightly lower than the value shown in the Display.
- 2) When **◀** is shown, the actual pitch is slightly higher than the value shown in the display.
- 3) When both **▶** and **◀** are shown, the value shown in the Display is almost equal to the actual pitch.

* The value you set is retained in memory even when the MKS-50 is switched off.

f. Patch Selection in the Internal Memory

A Patch consists of a Tone and the performance control functions. The MKS-50 can retain up to 128 different Tones and 128 different Patches, and you can select any of the Patches simply by pushing the relevant buttons.

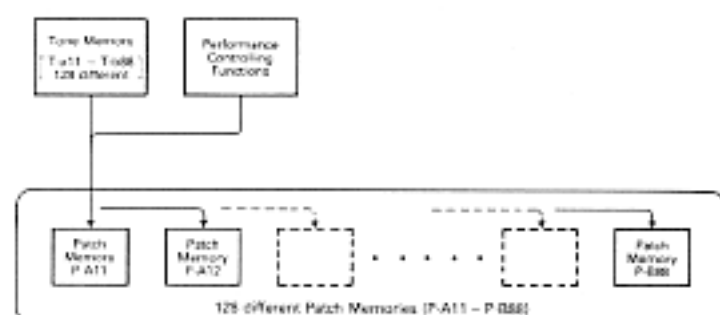

As shown in the picture below, Patches are divided into two Groups A and B, and each Group contains 8 Banks and 8 Numbers.

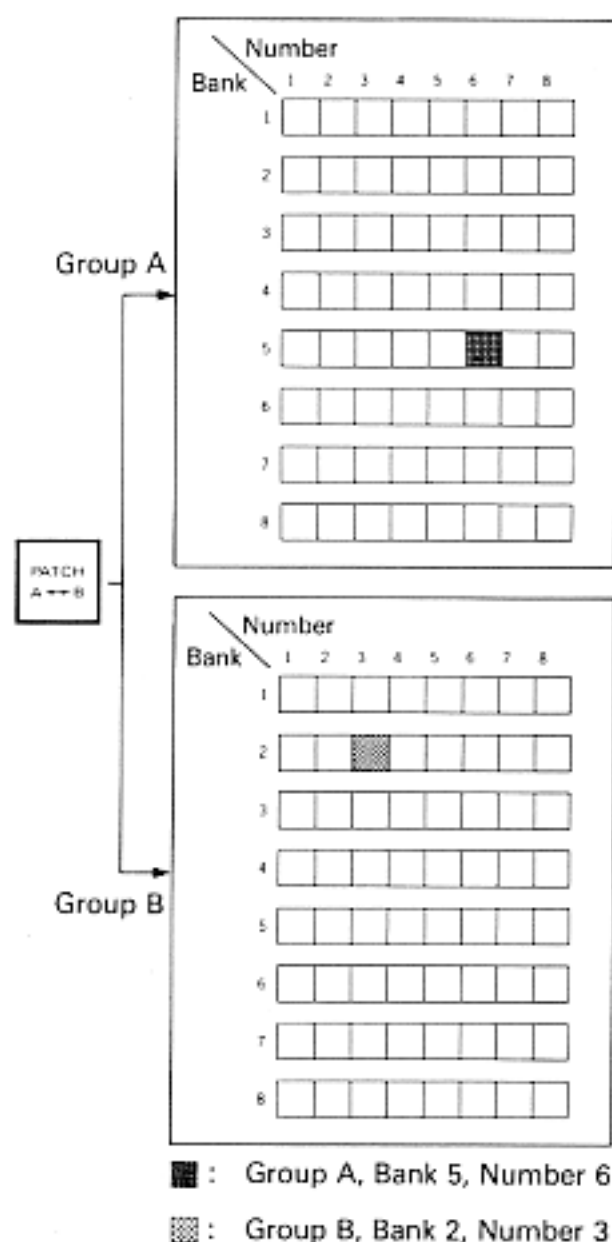

The Display shows the Patch in the combination of an alphabet and a number such as A56, B23 etc.

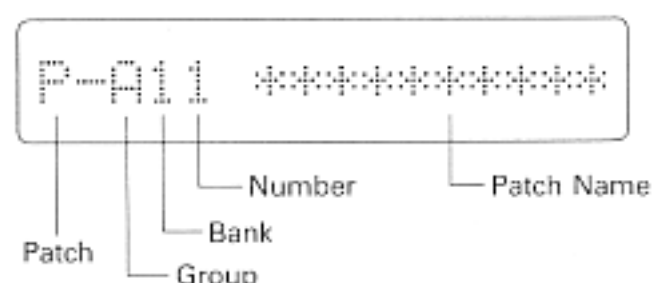

How to select a Patch

- 1 Push the Patch Button **10** to select the Group A or B.

Each time the Patch Button is pushed, the Group A and B are alternately selected.

- 2 Select the Bank (1 to 8) and the Number (1 to 8) by using the Number Buttons **12**.

First, select the Bank, and the Number area in the Display flashes, requiring you to select the Number.

* Either of the above procedures ① and ② can be taken first.

g. Patch Selection from the External Device

By sending the Program Change messages from the external MIDI device, the Patches on the MKS-50 can be changed.

The Program Change numbers correspond to the Patch Numbers as shown in the following table.

	BANK NO.	1	2	3	4	5	6	7	8
A	1	1	2	3	4	5	6	7	8
	2	9	10	11	12	13	14	15	16
	3	17	18	19	20	21	22	23	24
	4	25	26	27	28	29	30	31	32
	5	33	34	35	36	37	38	39	40
	6	41	42	43	44	45	46	47	48
	7	49	50	51	52	53	54	55	56
	8	57	58	59	60	61	62	63	64
B	1	65	66	67	68	69	70	71	72
	2	73	74	75	76	77	78	79	80
	3	81	82	83	84	85	86	87	88
	4	89	90	91	92	93	94	95	96
	5	97	98	99	100	101	102	103	104
	6	105	106	107	108	109	110	111	112
	7	113	114	115	116	117	118	119	120
	8	121	122	123	124	125	126	127	128

*Number 0 to 127 are used as Program Change Messages in the actual MIDI Format.

You can set the MKS-50 to ignore the Program Change messages:

- 1 Push the Tune/MIDI Button **4**.
- 2 Select "Program Change" by using the Parameter Button **8**.

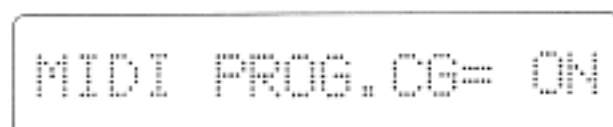

- 3 Select "OFF" with the Value Button **9**.

3 EDITING

The Patch and the Tone data in memory can be edited.

1. PATCH EDITING

a. Changing Tone Numbers in a Patch

① Select the Patch to be edited by pushing the relevant Number Buttons.

② Push the Tone Button ①.

The Display shows the Tone Number that the selected Patch consists of.

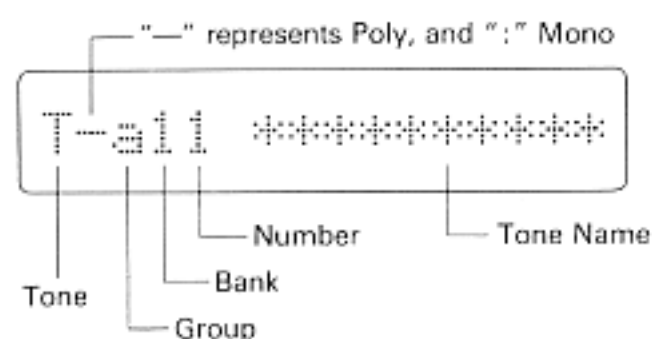

③ Using the Tone Button ①, select the Group a or b where the new Tone belongs.

④ Using the Number Buttons ⑫, set the Bank and the Number of the new Tone.

▶ While a Tone is shown in the Display (= the Display shows as above), the Tone can be heard by pushing the upper side of the Value Button ⑨.

▶ Changing the Tones will automatically rewrite the Patch Name by the same one as the new Tone Name. This Patch Name, however, can be changed by taking the appropriate Naming procedure explained on page 37.

▶ The data of the edited Patch will be erased when the unit is turned off. To retain the edited Patch in memory, take appropriate Writing procedure explained on page 22.

b. Changing Functions in a Patch

A Patch consists of Tone number and various performance controlling functions (e.g. Volume, Portamento, etc.)

Some functions can be directly set in the sounds on the MKS-50, and some can only select whether to receive or ignore the MIDI messages sent from the external device.

How to Change the Functions

- ① Select the Patch to be edited with the relevant Number Buttons.
- ② Push the Parameter Button until the Display shows the Function to be changed.

There are 18 functions which are called sequentially in the Display with the Parameter Button. If you go too far, you can return to the previous functions by pushing the lower side of the button.

Instead of the Parameter Button, you can use the Number Button ⑫ to assign the number of the Function.

Number	Function
1	Volume
2	MOD. Sense
3	Portamento
	Porta. Time
4	Key Shift
	Detune
5	Key Range Lo
	Key Range Hi
6	MIDI AFTER
	MIDI BENDER
	MIDI EXCL
	MIDI HOLD
	MIDI MOD
	MIDI VOLUME
	MIDI PORTA
7	MONO BEND
8	CHORD MEM No.
	ASSIGN MODE

- ③ Using the Value Button ⑨, change the value of the selected Function.

Pushing one side of the Value Button while holding the other side down will quicken the change of the value.

- ▶ The edited Function will be erased when you select other Patch. To retain the edited data in memory, take an appropriate writing procedure explained on page 21.

Function Table

- **Volume**

Volume =127

This Function can set an individual volume of each Patch, therefore can be used to reduce the volume difference between Patches. The value can be set from 0 to 127.

- **Modulation Sensitivity**

MOD. Sense = 32

When the MIDI Modulation Function (see page 21) is ON, the depth of the vibrato effect caused by MIDI signal can be changed from 0 to 127.

- **Portamento**

Portamento =OFF

Portamento is the slide of the pitch from one note to another. This function turn the Portamento effect on or off.

- **Portamento Time**

Porta. Time = 20

This function determines the portamento time from 1 to 127.

- **Key Shift**

Key Shift = 0

This can shift the pitch of the sound from -12 to +12 (an octave) in semi-tone steps.

- **Detune**

Detune = 0

This can shift the pitch set with TUNING from -63 to +63 (approx. ± 25 cents).

● Key Range (Low/High)

Key Range Lo=C 0

Key Range Hi=C 8

These Functions determine the sound range of the MKS-50.

The Key Range set here is based on the keyboard of normal key condition. If the Key Shift Function is used or the Tone's DCO Range parameter is set to other than 8°, the actual pitch will differ from the key on the keyboard.

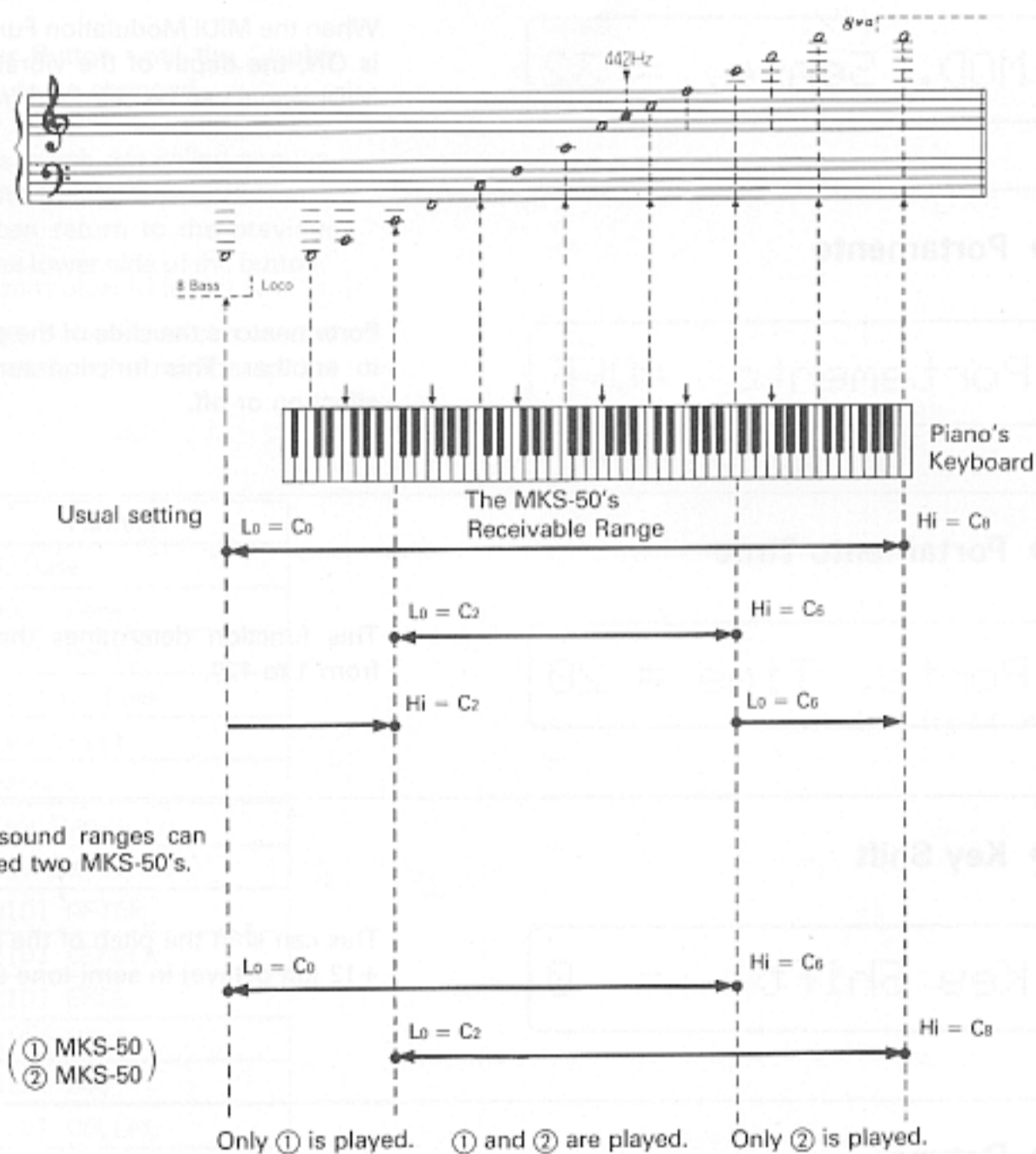

● MIDI Aftertouch

MIDI AFTER = ON

This turns on or off the MIDI Aftertouch message.

- **MIDI Bender**

MIDI BENDER = ON

This turns the MIDI Bender message on or off.

- **MIDI Exclusive**

MIDI EXCL = ON

The MIDI Exclusive message (strictly of the Roland ID Number) can be transmitted and received. (See page 49 to 51.)

- **MIDI Hold**

MIDI HOLD = ON

This turns the MIDI Hold message on or off.

- **MIDI Modulation**

MIDI MOD = ON

This turns the MIDI Modulation message on or off.

- **MIDI Volume**

MIDI VOLUME = ON

This turns the MIDI Volume message on or off.

- **MIDI Portamento**

MIDI PORTA = ON

This turns the MIDI Portamento message on or off.

- **Mono Bender Range**

MONO BEND = 12

When using the device that features MIDI Mono mode such as MIDI Guitar System, this Function sets the maximum effect of the Bender from 0 to 12 (one octave) in semi-tone steps. The value set here has priority to the DCO Bender Range (explained later in this manual).

c. Writing a Patch

The edited Tone Number(s) and Functions of a Patch can be written in memory.

- ① Push the Tune/MIDI Button ④.
- ② Push the lower side of the Parameter Button ⑧ once.

"Memory Protect" is shown in the Display.

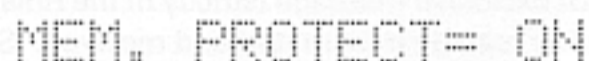

MEM. PROTECT= ON

- ③ Using the Value Button, select "OFF".
- ④ Push the Patch Button ⑩ once.
- ⑤ Push the Write Button ⑦.

The Number of the selected Patch is shown in the Display.

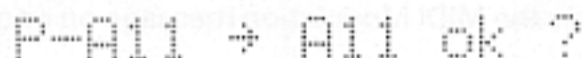

P-All → All ok ?

Flashing

- ⑥ Push the Write Button.
- ⑦ Repeating the steps ① to ③, set the Memory Protect to ON.

If you wish to write the edited Patch to a different Patch Number, take the following procedure after the Step ⑤.

- ⑥ Select the Group A or B which contains the Patch Number (new location) where the edited Patch is to be written by using the Patch Button ⑩.

If the relevant Group is already selected, skip the above step.

- ⑦ Using the Number Buttons ⑫, assign the Bank, then the Number of the Patch.

In the Display, check if the Patch Number is correct. If it is wrong, push the Patch Button ⑩ and reassign the correct one by repeating the steps ⑤ to ⑦.

- ⑧ Push the Write Button.

- ⑨ Repeating the steps ① to ③, set the Memory Protect to ON.

▶ Memory Protect is the function that prevents the data from accidental erasure. If you try to write the data with this Memory Protect set to ON, the Display responds with as shown below without rewriting the data.



Memory Protected

2. TONE EDITING

A Tone consists of various Parameters, so a Tone can be edited by changing the values or settings of those parameters.

The Tone editing can be done much quicker and easier by using the optional programmer PG-300. To edit the existing Tone drastically or synthesize from scratch, the PG-300 is essential.

► The edited Tone will be erased when other Patch or Tone is selected. If you wish to retain the edited Tone in memory, take the Writing procedure explained on page 36.

a. Editing Tone Parameters

You can call any of the Tone Parameters and edit it.

To study what each parameter can do, refer to the following section "b. Tone Parameters".

How to edit Tone Parameters

- ① By using the Tone Button **1** and the Number Button **2**, select the Tone to be edited.
- ② Push the Parameter Button **3** until the Display shows the parameter to be changed.

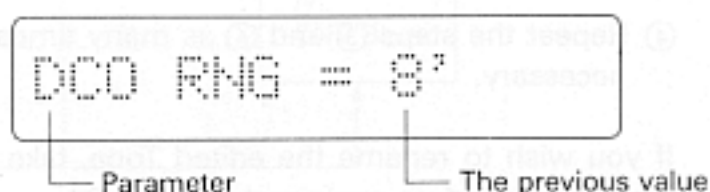

The Tone Parameter can be called sequentially in the Display with the Parameter Button. If you go too far, you can return to the previous parameters by pushing the lower side of the button.

Instead of the Parameter Button, you can use the Number Button **2** to assign the number of the Parameter.

This oscillator generates extremely low frequency to produce a vibrato or growl effect by controlling the frequency.

Number	Tone Parameter	
1	DCO RNG	DCO Range
2	PULSE	DCO Pulse Waveform
3	PW/PWM	DCO PW/PWM Depth
4	UCF FREQ	VCF Cutoff Frequency
5	VCA LEVL	VCA Level
6	CHORUS	Chorus
7	LFO RATE	LFO Rate
8	ENV	ENV Time

- ③ Using the Value Button **9**, change the value of the selected Parameter.

DCO RNG = 8' + 8'

The new value

Pushing one side of the Value Button while holding the other side down will quicken the change of the value.

- ④ Repeat the steps ③ and ④ as many times as necessary.

If you wish to rename the edited Tone, take the Naming procedure explained on page 37.

Parameter	Value
DCO Range	8' + 8'
DCO Pulse Width	8'
DCO Pulse Delay	8'
VCF Cutoff Frequency	8'
VCA Level	8'
Chorus	8'
Reverb	8'
FXV Tone	8'



b. Tone Parameters

The Tone Parameters are roughly divided into seven blocks as shown below.

Please study what each Parameter can do with the Tone Parameter Table.

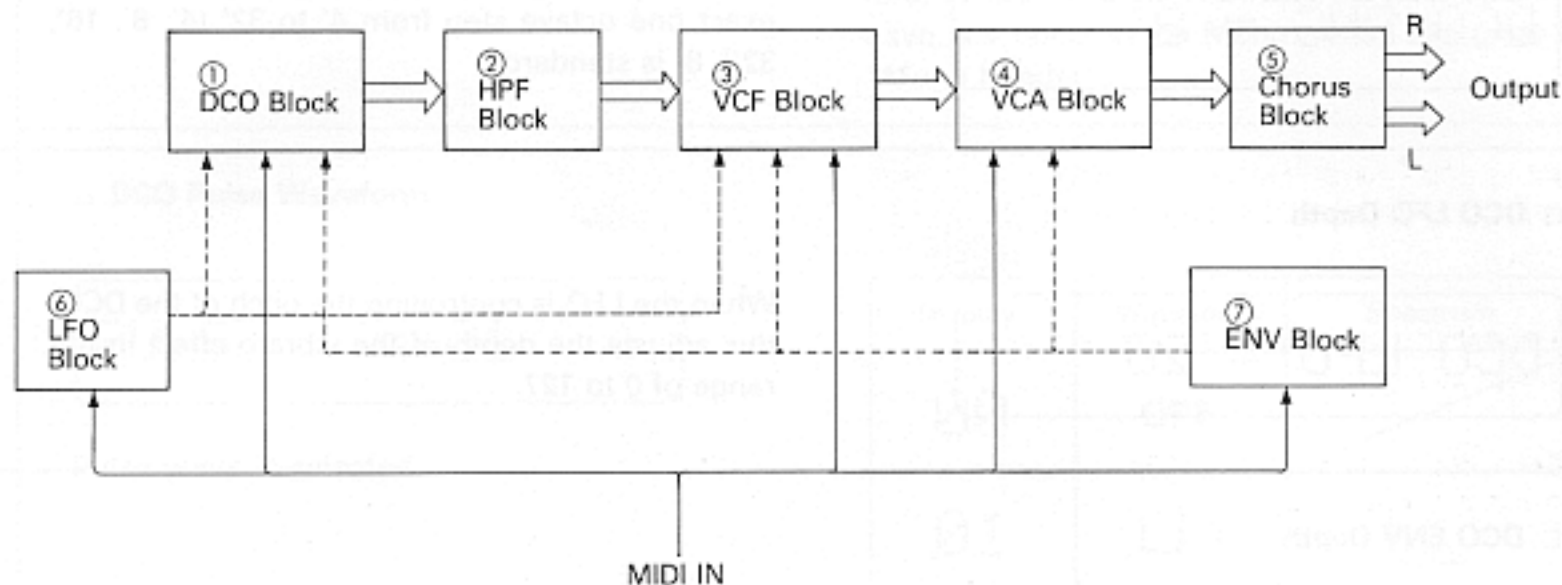

① DCO (Digitally Controlled Oscillator)

DCO is the digitally controlled oscillator that controls the pitch and generates the waveforms that are the sound source of the synthesizer.

② HPF (High Pass Filter)

The HPF (High-Pass Filter) is a filter that passes high frequency harmonics and cuts off the lower ones. This changes the waveform and controls the tone color.

③ VCF (Voltage Controlled Filter)

Each VCF lets lower frequency harmonics of the input signal pass and cuts off the higher ones. In other words, it is a usual low pass filter. By controlling the cutoff point and resonance, the waveform changes, thereby the tone color alters.

④ VCA (Voltage Controlled Amplifier)

After filtered in the VCF, the signal is fed to the VCA where the volume (amplitude) of the sound is controlled by the signal from the ENV Block or Gate signal.

⑤ CHORUS

⑥ LFO (Low Frequency Oscillator)

This oscillator generates extremely low frequency, so produces a vibrato or growl effect by controlling the DCO or VCF.

⑦ ENV (Envelope Generator)

This generates the control voltage (Envelope) which controls the DCO, VCF and VCA, therefore, alters the pitch, tone color and volume in each note.

Tone Parameter Table

DCO (Digitally Controlled Oscillator)

DCO Range

DCO RNG = 8'

This is to change the pitch range of the DCO in exact one octave step from 4' to 32' (4', 8', 16", 32'). 8' is standard.

DCO LFO Depth

DCO LFO = 20

When the LFO is controlling the pitch of the DCO, this adjusts the depth of the vibrato effect in the range of 0 to 127.



DCO ENV Depth





DCO ENV = 60

When the ENV is controlling the pitch of the DCO, this parameter sets the depth of the modulation in the range of the 0 to 127.

DCO ENV Mode

DCO ENV = 

This selects the polarity of the Envelope curve that controls the DCO. Usually  may be used. In  mode, ADSR pattern will be inverted.

Mode	Display	Function
Normal		ENV serves to increase the DCO's pitch.
Invert		ENV serves to decrease the DCO's pitch.
Normal with Dynamics		The ENV with Dynamics serves to increase the DCO's pitch.
Invert with Dynamics		The ENV with Dynamics serves to decrease the DCO's pitch.

DCO Aftertouch Sensitivity

DCO AFTR= 15

This parameter determines the depth of the vibrato effect when it is controlled by aftertouch. 0 to 15 are valid for this parameter.

DCO Bender Range

DCO BEND= 12

This sets the maximum effect of the Pitch Bender caused by moving the Pitch Bender. 0 to 12 are valid for this parameter, and 1 is semi-tone, therefore, 12 is an octave. The value set here does not have any effect in the Mono mode. See page 28 "Mono Bender".

DCO Pulse Waveform

PULSE = 01

Pulse wave is selected.

Display	Waveform	Spectrum
00	OFF	
01		
02		
03		See page 28 "DCO PW/PWM Depth"

* The pulse width of 03 can be set at DCO PW/PWM Depth.

DCO Sawtooth Waveform

SAWTOOTH= 01

Sawtooth waveform is selected.

Display	Waveform	Spectrum
00	OFF	
01		
02		
03		See page 21 "DCO PW/PWM Depth"
04		
05		

* The pulse width of 03 can be set at DCO PW/PWM Depth.

Tone Parameter Table

□ DCO Sub Oscillator Waveform

SUB = 00

This selects the waveform of the Sub Oscillator that generates the pitch 1 or 2 octaves lower than the pulse wave or sawtooth wave.

Display	Waveform	Pitch	Spectrum
00		1 oct. lower	
01		1 oct. lower	
02		1 oct. lower	
03		1 oct. lower	
04		2 oct. lower	
05		2 oct. lower	

□ DCO Sub Oscillator Level

SUB LEVEL = 03

This sets the volume of the Sub Oscillator from 0 to 3. At 0, there is no oscillation.

□ DCO Noise Level

NOIS LVL = 03

This sets the volume of the Noise which is often used for wind or surf. 0 to 3 are valid, and at 0, there is no Noise generated.

Noise



□ DCO PW/PWM Depth

PW / PWM = 00

This parameter works only on the Pulse Wave 03 and Sawtooth Wave 03. The pulse width of a wave can be determined by the value from 0 to 127.

PW/PWM Depth	PULSE 03		SAWTOOTH 03	
	Waveform	Spectrum	Waveform	Spectrum
00				
42				
64				
102				
127				

□ DCO PWM Rate

PWM RATE= 60

This parameter works only on the Pulse Wave 03 and Sawtooth Wave 03. The rate of the LFO modulation that changes the pulse width of the waveform can be set. 0 to 127 are the values valid for this parameter. At 0, however, the pulse width is not modulated by the LFO but set at the PW/PWM Depth. When this parameter is set to the value other than 0, the pulse width set with the DCO PW/PWM Depth is the widest pulse made by the LFO modulation.

HPF (High Pass Filter)

□ HPF Cutoff Frequency

HPF FREQ= 02

This parameter changes the cutoff point of the HPF.

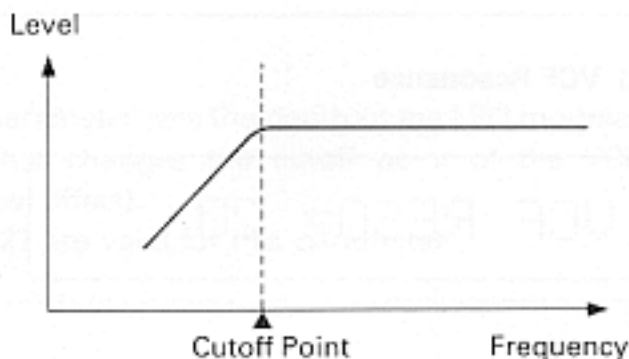

Display	Function	
00	The lower frequencies are emphasized, (This is useful for fat bass sound.)	
01	HPF is off.	
02	Cutoff point is set at lower frequency.	
03	Cutoff point is set at higher than 02. The produced sound is harder and thinner than that of 02.	

VCF (Voltage Controlled Filter)

□ VCF Cutoff Frequency

VCF FREQ= 80

This is for changing the cutoff point of the VCF. As you decrease the value, the cutoff frequency will come down, and the waveform gradually becomes approximation of a sine wave, then the sound will fade out.

0 to 127 are valid for this parameter.

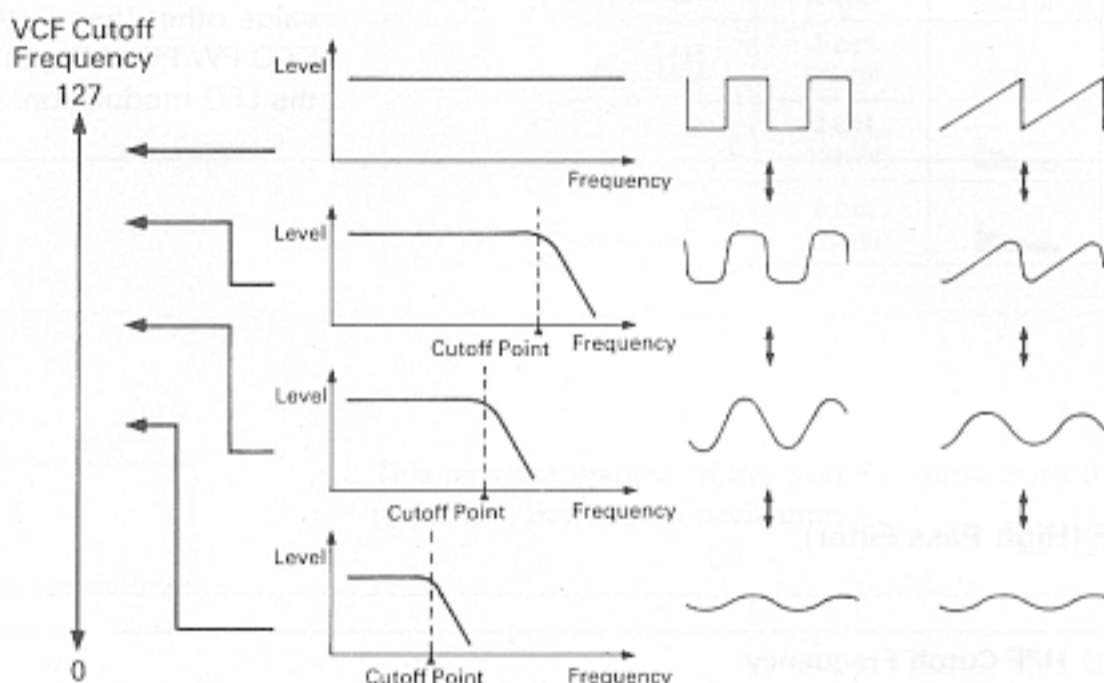

□ VCF Resonance

VCF RESO= 20

This parameter emphasizes the cutoff point set at the VCF Cutoff Frequency. As you increase the value, the created sound will become more unusual, more electronic in nature.

0 to 127 are valid for this parameter.

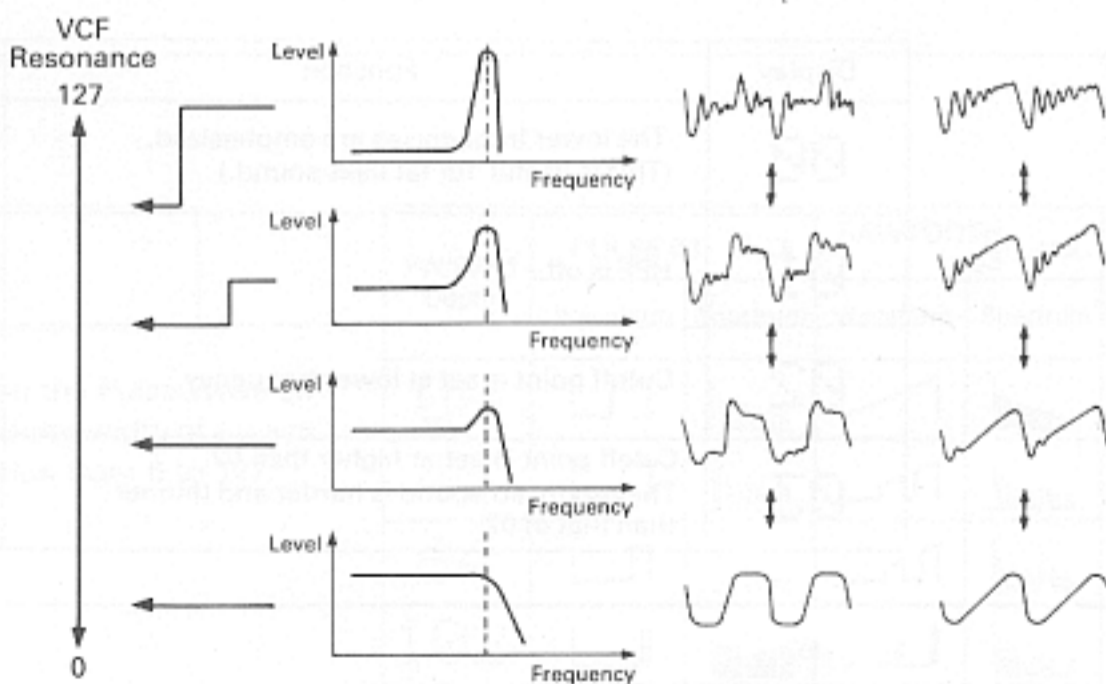



VCF ENV Depth





VCF ENV = 60

This parameter controls the cutoff point of the VCF in each note with the ENV curve set in the ENV section. As you increase the value, tone color within one note changes more drastically. 0 to 127 are valid for this parameter.

VCF ENV Mode

VCF ENV = 

This is to select the polarity of the Envelope curve that controls the cutoff point of the VCF. Usually, "

Mode	Display	Function
Normal		ENV serves to increase the VCF's cutoff point.
Invert		ENV serves to decrease the VCF's cutoff point.
Normal with Dynamics		The ENV with Dynamics serves to increase the VCF's cutoff point.
Dynamics		This mode is rather special; the ENV has nothing to do with the VCF's cutoff point and the Dynamics directly works to increase the VCF's cutoff point.

VCF LFO Depth

VCF LFO = 60

This parameter sets the depth of the LFO modulation that changes the cutoff point of the VCF (=growl effect). 0 to 127 are valid for this parameter.

VCF Keyboard Follower

VCF KYBD= 15

This parameter can shift the cutoff point depending on the pitch of the note. 0 to 15 are valid, and decreasing the value will make the higher pitch softer.

VCF Aftertouch Sensitivity

VCF AFTR= 15

When the Aftertouch is controlling the cutoff frequency of the VCF, this parameter sets the sensitivity of the effect. 0 to 15 are valid for this parameter.

VCA (Voltage Controlled Amplifier)

□ VCA Level

VCA LEVL= 64

This is for changing the volume, and can be effectively used when writing a tone color. When the value is set too high, sound may be distorted.

□ VCA ENV Mode

VCA ENV = ENV

This is to select whether to control the VCA by the signal from the ENV or by the Gate signal (MIDI NOTE ON/OFF signal).

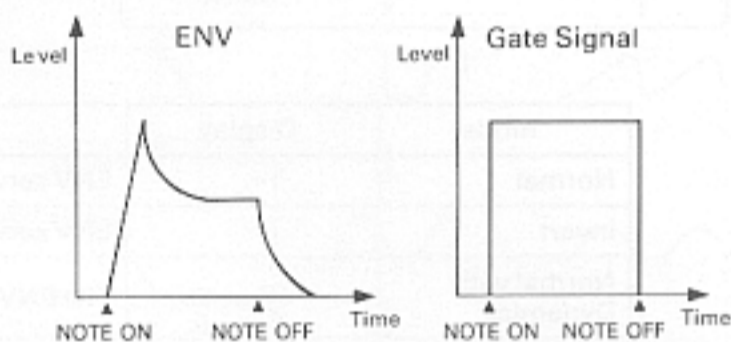

Mode	Display	Function
ENV	ENV	ENV changes the volume.
Gate	GT	Gate signal changes the volume.
ENV with Dynamics	ENV	ENV with dynamics changes the volume.
Gate with Dynamics	DGT	Gate signal with dynamics changes the volume.

□ VCA Aftertouch Sensitivity

VCA AFTR= 15

When the Aftertouch is controlling the volume, this parameter determines the sensitivity of the effect.
0 to 15 are valid for this parameter.

CHORUS

Chorus On/Off

CHORUS = ON

This turns on or off the Chorus effect.

Chorus Rate

CRS RATE= 70

This parameter determines the rate of the chorus effect from 0 to 127.

LFO (Low Frequency Oscillator)

LFO Rate

LFO RATE= 70

This parameter changes the rate of the LFO modulation.
0 to 127 are valid for this parameter.

LFO Delay Time

LFO DELY= 20

This parameter sets the time needed for the LFO modulation to work from the moment the key is played.
0 to 127 are valid for this parameter.

<Fig. 1>

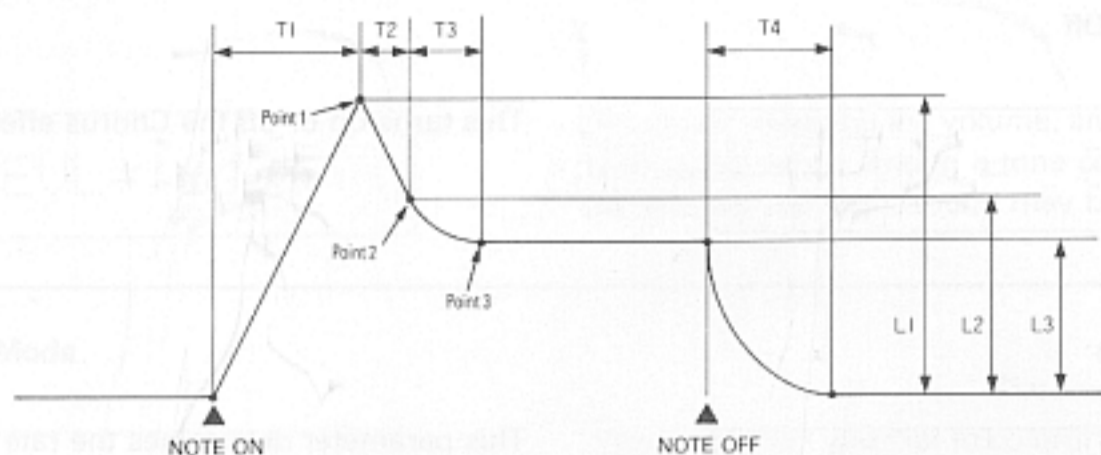
 ENV Time 1

ENV T1 = 00

This parameter can set the time needed for a note to reach the point 1 from the moment of NOTE ON. 0 to 127 are valid for this parameter.

In Fig 1, T1 represents it.

 ENV Level 1

ENV L1 = 127

This parameter sets the point 1's level. 0 to 127 are valid for this parameter.

In Fig 1, L1 represents it.

 ENV Time 2

ENV T2 = 20

This parameter can set the time spent for a note to change from the point 1 to 2. 0 to 127 are valid for this parameter.

In Fig 1, T2 represents it.

 ENV Level 2

ENV L2 = 80

This parameter sets the point 2's level. 0 to 127 are valid for this parameter.

In Fig 1, L2 represents it.

 ENV Time 3

ENV T3 = 20

This parameter can set the time spent for a note to change from the point 2 to 3. 0 to 127 are valid for this parameter.

In Fig 1, T3 represents it.

 ENV Level 3

ENV L3 = 60

This parameter sets the point 3's level. 0 to 127 are valid for this parameter.

In Fig 1, L3 represents it.

 ENV Time 4

ENV T4 = 50

This parameter sets the time needed for a note to fall to 0 from the level 3 from the moment of NOTE OFF.

0 to 127 are valid for this parameter.

In Fig 1, T4 represents it.

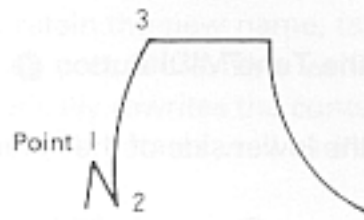
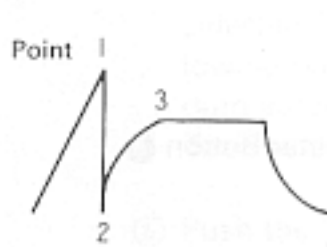
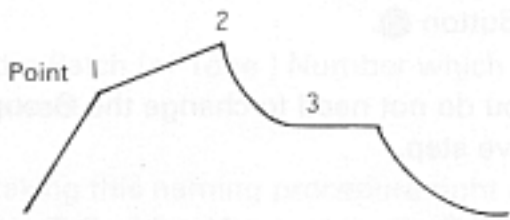

- Such an Envelope Curve can be produced.

□ ENV Keyboard Follower

ENV KYBD= 15

The time required for the envelope to complete its curve can be changed depending on the pitch of the note.

0 to 15 are valid for this parameter.

There is no change of the time at all when it is set to 0, but as the value is increased, envelope time becomes shorter with higher key pressed.

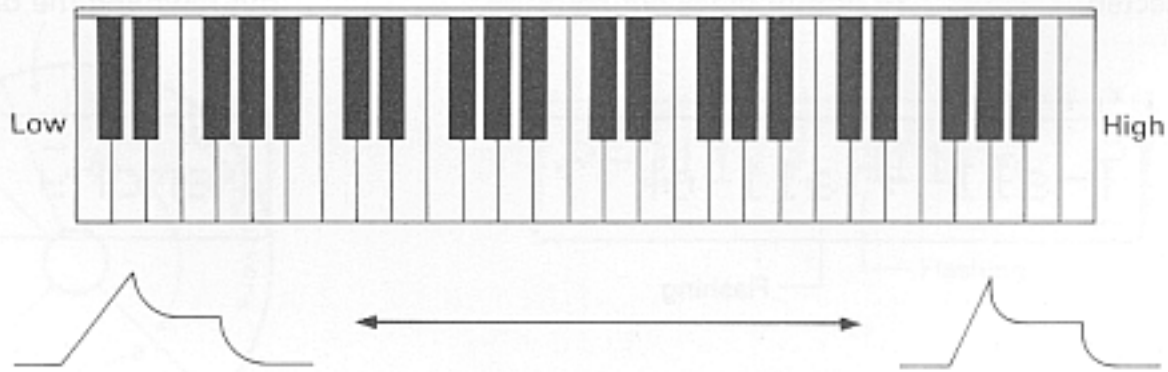

c. Writing a Tone

The edited Tone can be written into memory:

- ① Push the Tune/MIDI Button ④.
- ② Push the lower side of the Parameter Button ⑧ once.

The Display shows "Memory Protect".

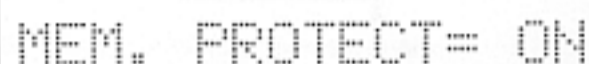

MEM. PROTECT= ON

- ③ Select "OFF" by using the Value Button ⑨.
- ④ Push the Tone Button ⑩ once.
- ⑤ Push the Write Button ⑦.

The Display shows the Tone Number currently selected.

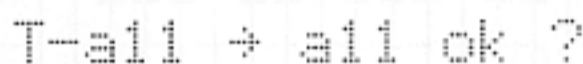

T-all → all ok ?

Flashing

If you wish to write the edited Tone into the same Tone Number, skip the steps ⑥ and ⑦ and go to the step ⑧.

If you wish to write the edited Tone into a different Tone Number, go to the step ⑥.

- ⑥ Select the Group a or b by using the Patch Button ⑩.

If you do not need to change the Groups, skip the above step.

- ⑦ Using the relevant Number Buttons ⑫, select the Bank and the Number of the Tone where the edited data is to be written.

Check if the correct Tone Number is selected by the Display. If it is not the correct one, reassign the correct number by repeating the steps ⑤ to ⑦.

- ⑧ Push the Write Button.
- ⑨ Taking the same procedure as steps ① to ③, turn the Memory Protect to ON.

▶ Memory Protect is the function that protects the data in memory from accidental erasure. If you try to write a new data with the Memory Protect ON, the Display shows as below without rewriting the data.

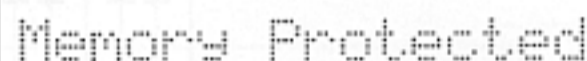

Memory Protected

3. NAMING

Each Patch and Tone can be renamed using up to ten letters.

- ① Select the Patch (or Tone) Number which is to be renamed.

If you are taking this naming procedure right after the Patch (or Tone) is edited, push the Patch (or Tone) Button once more.

- ② Push the Name Button ⑤.

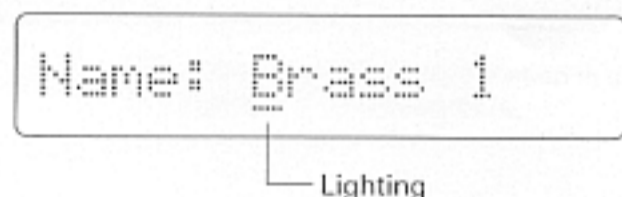

- ③ Move the cursor to the letter to be changed by using the Parameter Button ⑧.

- ④ Change the letter using the Value Button ⑨.

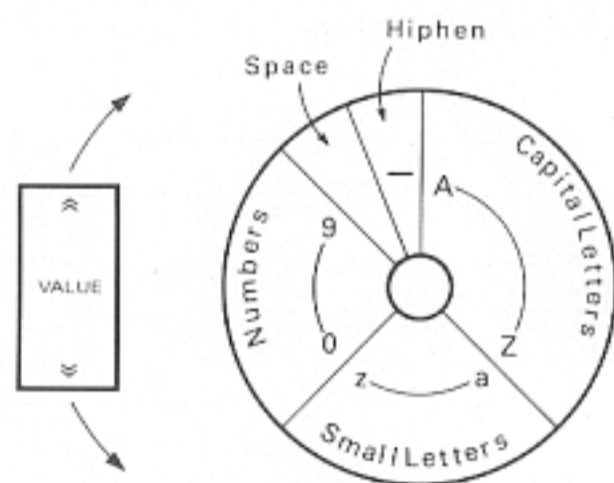

- ⑤ Repeat the steps ③ and ④ as many times as necessary.

► The Tone or Patch Name you have set will be erased when a different Patch or Tone is selected. To retain the new name, take the following writing procedure. This writing procedure automatically rewrites the contents of the Tone or the Patch data as well as the name.

- ⑥ Push the Tune/MIDI Button ④.

- ⑦ Push the lower side of the Parameter Button ⑧ once.

The Display shows "Memory Protect".

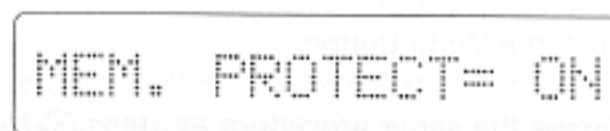

- ⑧ Select "OFF" by using the Value Button ⑨.

- ⑨ Push the Patch (or Tone) Button ⑩ once.

- ⑩ Push the Write Button ⑦.

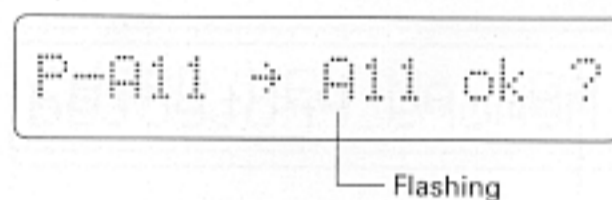

The Display shows the Patch (or Tone) Number currently selected.

If you wish to write the edited Patch (or Tone) into the same Patch (or Tone) Number, skip the steps ⑩ and ⑪ and go to the step ⑬.

If you wish to write the edited Tone into a different Tone Number, go to the step ⑪.

- ⑪ Select the Group (flashing) a or b by using the Patch Button ⑩.

If you do not need to change the Groups, skip the above step.

- ⑫ Using the relevant Number Buttons ⑫, select the Bank and the Number of the Patch (or Tone) where the edited data is to be written.

Check if the correct Patch (or Tone) Number is selected by the Display. If it is not the correct one, reassign the correct number by repeating the steps ⑩ to ⑫.

- ⑬ Push the Write Button.

- ⑭ Taking the same procedure as steps ⑥ to ⑧, turn the Memory Protect to ON.

▶ Memory Protect is the function that protects the data in memory from accidental erasure. If you try to write a new data with the Memory Protect ON, the Display shows as below without rewriting the data.

Memory Protected

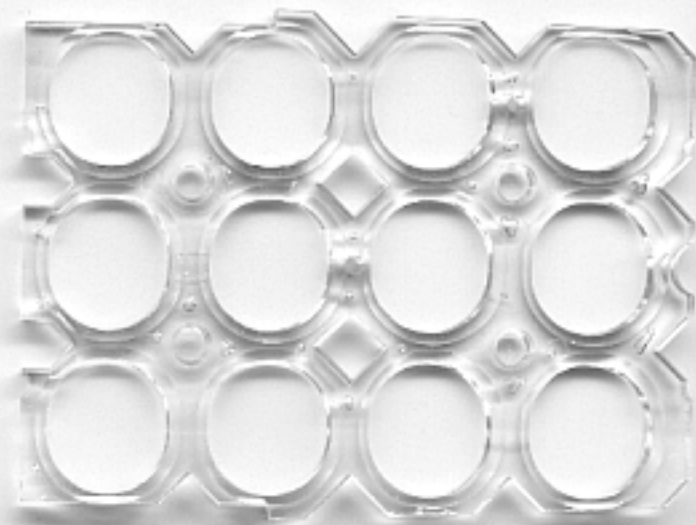

1. CHORD MEMORY

The MKS-50 features the Chord Memory function that allows to play a chord with a single key. 16 different Chords are preprogrammed in the MKS-50, and any of them can be assigned to the Patch you select. The preprogrammed Chords are volatile, therefore can be rewritten.

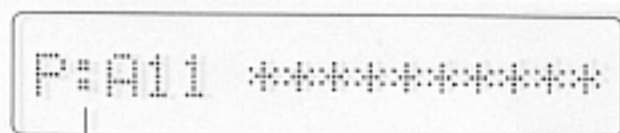

When the Chord Memory function is used in a Patch, ":" is shown here.

<PROCEDURE>

- ① Push the Patch you wish to play in chord.
- ② By using the Parameter Button **8**, select "Assign Mode".



mono (Mono Mode)
poly (Poly Mode)
C.M. (Chord Memory)

- ③ Select "Chord Memory" by using the Value Button **9**.
- ④ Push the lower side of the Parameter Button **8** once.

The Display shows "Chord Memory Number".

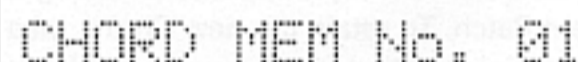

Chord Memory Number

- ⑤ While actually listening to the sound, select the Chord Memory Number you like with the Value Button ⑨.

16 different Chords are preprogrammed as shown below.

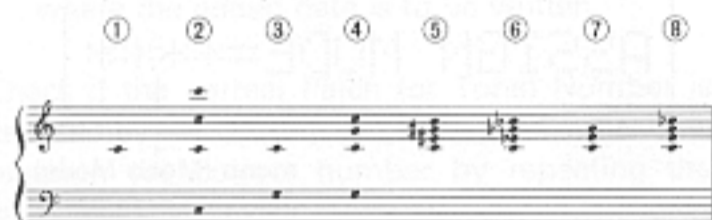

- The new Chord Memory Number you select will be automatically erased by selecting a different Patch. To retain the new Chord, take the appropriate writing procedure as explained in "c. Writing a Patch" on page 22.

* If you play the instrument extremely fast, too many NOTE ON messages are continuously fed in, therefore, the chords may not sound properly.

You can rewrite the existing chord data by playing the connected keyboard or by operating the MKS-50. (In the MIDI Mono mode, only the later method is available.)

- ① Push the Tune/MIDI Button ④.
- ② Push the lower side of the Parameter Button ⑧ once.

The Display shows "Memory Protect".

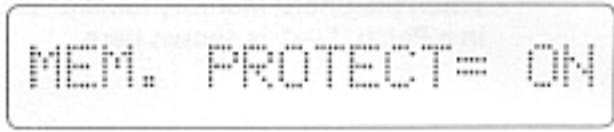

- ③ Using the Value Button ⑨, select "OFF".
- ④ Using the Parameter Button ⑧, select "Chord Memory".



- ⑤ Push the Write Button ⑦.

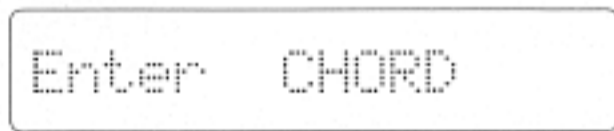

To rewrite the Chord data by playing the keyboard, play the chord here. Then go to the step ⑩. The Chord can be set within the range of 2 octaves upper and lower from C4 key. (The exceeding note will be ignored.)

2. MODE SELECTION

To write a Chord by operating the MKS-50, continue to the following procedure.

- ⑥ Push the Parameter Button **8**.

The Display shows the pitch of the first note of the chord.

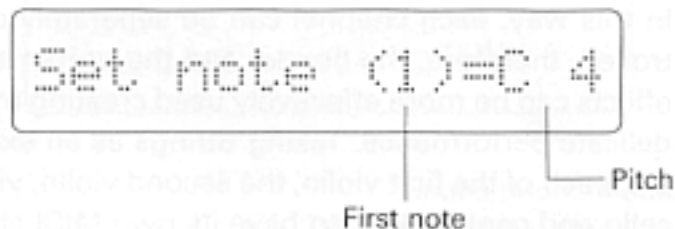

- ⑦ By pushing the Value Button **9**, set the pitch within the range of two octaves upper or lower from the C4 key.

- ⑧ Push the upper side of the Parameter Button **9**.

The Display shows the pitch of the second note.

- ⑨ Repeat the steps ⑦ and ⑧ as many times as necessary (up to the sixth note).

If you do not want any more note for the chord, select "off" with the Value Button instead of setting the pitch. Once "off" is set, no note is set any longer.

"off" always comes just before "C4".

- ⑩ Push the upper side of the Parameter Button **8**.

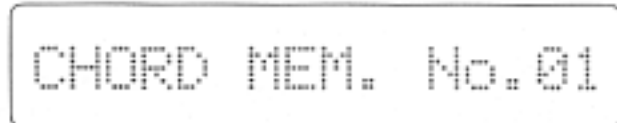

- ⑪ Using the Value Button **9**, select the Chord Memory Number where the chord you have set is to be written.

- ⑫ Push the Write Button.

- ⑬ By repeating the steps ① to ③, set the Memory Protect to ON.



- ⑭ Select "OFF" with the Value Button.

The above setting will remain even after power is switched off.

- ⑮ Select "ON" with the Value Button.

2. MODE SELECTION

Usually, the MKS-50 can be set to either the Poly or the Mono mode by taking initializing procedure as explained "Initialization" in "[2] Playing". The initialization automatically turns all the Patches either to Mono or Poly modes. The following Mode Selecting procedure allows to set the mode of each Patch individually to Mono or Poly.

The Display shows which mode is selected:

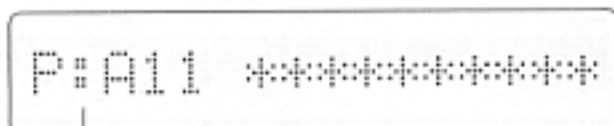

"—" represents Poly, and ":" Mono

Before going to the Mode Selection procedure, study the following explanation on Mono and Poly modes.

• Mono Mode

MIDI Mono Mode is the function that enables to play different sounds on an instrument by an external controller using that many MIDI channels. In this way, each channel can be separately controlled, therefore, the bender and the portamento effects can be more effectively used creating more delicate performance. Taking Strings as an example, each of the first violin, the second violin, viola, cello and contrabass can have its own MIDI channel individually, allowing to play each part more delicately.

- * The MKS-50 allows to use up to six MIDI channels.
- * If the external MIDI device can transmit only Poly Mode signal, the Mono Mode will turn the MKS-50 to a simple monophonic synthesizer.

• Poly Mode

Poly Mode is the usual polyphonic mode that allows to receive up to six voices on one MIDI channel. Usually, a keyboard can transmit the message only on one MIDI channel, therefore, should be set to this mode. When playing several MIDI instruments at a time with a computer or sequencer, the Mono Mode is not appropriate as it could easily require more than 16 MIDI channels.

How to select MIDI Mono or Poly Mode

- ① Select the patch whose MIDI Mode you wish to change.
- ② Push the Parameter Button **8** until the Display shows:

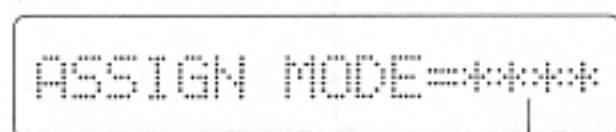

ASSIGN MODE=****

mono (Mono Mode)
poly (Poly Mode)
C.M. (Chord Memory)

- ③ Using the Value Button **9**, select Mono or Poly mode.

▶ About C.M. (Chord Memory), see the previous section "1. Chord Memory" on page 42.

▶ The MIDI Mode you have set will be erased when you select a different Patch. To retain the MIDI Mode data in memory, take the appropriate writing procedure as shown in "c. Writing a Patch" on page 22.

* The MIDI Mode message sent from the external MIDI device will have priority to the MIDI Mode you have set on the MKS-50.

You may wish to set the MKS-50 to ignore the MIDI Mode set in each Patch, in other words to change Patches without changing the MIDI Mode setting. If so, do as follows.

- ① Push the Tune/MIDI Button **4**.
- ② Push the Parameter Button **8** until the Display responds with:

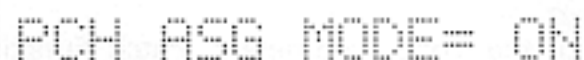

PCH ASG MODE= ON

- ③ Select "OFF" with the Value Button **9**.

The above setting will remain even after the unit is switched off.

To cancel the above setting, select "ON" in the step ③.



PCH ASG MODE= OFF

The number "1" appears in the Display when the saving is completed.

④ If you use the meter function recording level control, set the level so that the meter will read 0.50 when "3" is shown in the Display.

When the saving is completed, the Display shows with



PCH ASG MODE= OFF

⑤ Stop the tape recording.

▶ Please take a minute to try out the operation procedure shown on this page right after the saving.

3. DATA TRANSFER

The data in the MKS-50's memory will be erased when the battery that supports the memory back-up system becomes exhausted. To prevent the loss of data, the MKS-50 features the tape interface function that allows to save the data (Patch, Tone and Chord) in the MKS-50's memory onto a usually cassette tape.

The Roland MIDI Exclusive Message makes it possible to copy the data in the MKS-50 to the other device (e.g. other MKS-50, Alpha Juno, HS-80)

Each of the Tone Parameters, Patch Functions, Chord Memory data can also be transmitted separately by means of Exclusive message.

a. Saving on a Tape

The MKS-50's data is divided into 5 groups as shown below. This makes it possible to exchange data (bulk dump) between the MKS-50 and other device such as the Alpha Juno. Therefore, to transfer entire data of the MKS-50, each of the five data groups should be saved onto a tape, verified, then later loaded back to the MKS-50.

Data	Display	Group
Tone	[T-a]	Tones in Group a × 64
	[T-b]	Tones in Group b × 64
Patch	[P-A]	Patches in Group A × 64
	[P-B]	Patches in Group B × 64
Chord Memory	[CM]	Chord Memory × 16

1) Connection

SAVING

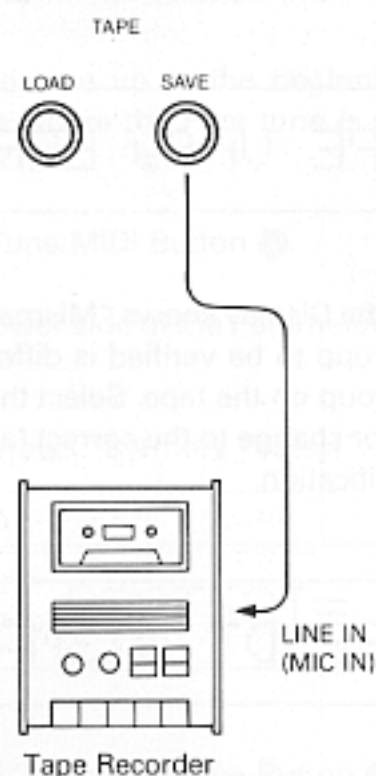

LOADING, VERIFICATION

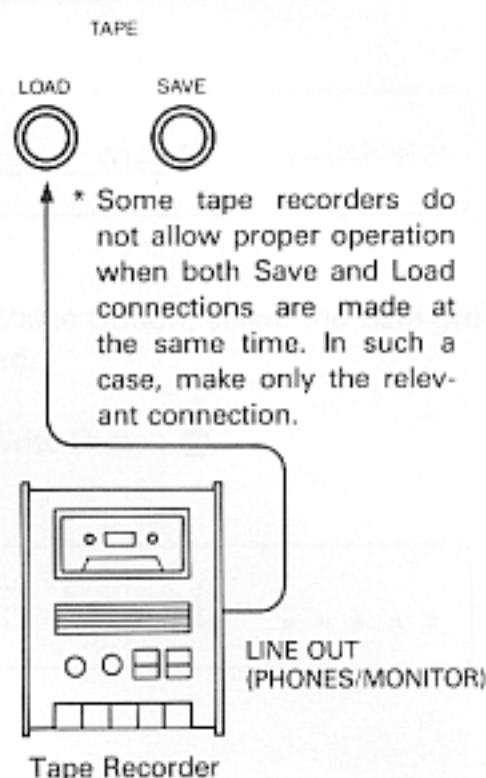

2) Tape Saving

- ① Push the Data Transfer Button ⑥.
- ② Push the Parameter Button ⑧ until the Display shows "Tape Save".

TAPE Save * * * * *

Data Group

- ③ Using the Value Button ⑨, select the Data Group.
- ④ Set the tape recorder to the recording mode and start recording.
- ⑤ Push the Write Button ⑦ on the MKS-50.

TAPE Save 0

The number increases as the saving is proceeding.

- ⑥ If your tape recorder features recording level control, set the level so that the meter will read 0 VU while "0" is shown in the Display.

When the saving is completed, the Display responds with:

TAPE Save . . End.

- ⑦ Stop the tape recorder.
- Please make it a rule to take the following verification procedure (shown on the next page) right after the saving.

3) DATA TRANSFER

3) Tape Verification

- ① Rewind the tape up to the beginning of the saved data where the Pilot tone is previously recorded.
- ② Push the Data Transfer Button **6**.
- ③ Push the Parameter Button **8** until the Display shows "Tape Verify".



TAPE Vrfy * * * * *

Check if the correct Data Group which has been saved is now shown in the Display.

- ④ Push the Write Button **7**.

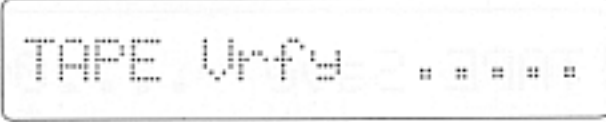

TAPE Vrfy

- ⑤ Set the tape recorder to the playback mode then start the tape.

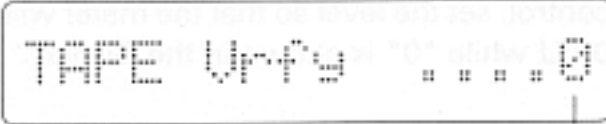

TAPE Vrfy 0

The number increases as the verification is proceeding.

When the verification is completed, the Display responds with:



TAPE Vrfy . . End.

- ▶ When error indication is shown in the Display, read "Notes on saving on a tape" on page 48, then carefully repeat the saving procedure.



TAPE Vrfy ERR

- ▶ When the Display shows "Mismatch Data", the data group to be verified is different from the data group on the tape. Select the correct data group or change to the correct tape and repeat the verification.

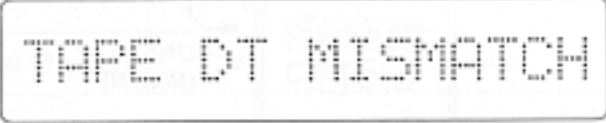

TAPE DT MISMATCH

- ⑥ Stop the tape recorder.

4) Tape Loading

Loading the data back to the MKS-50's memory will automatically erase any data previously written.

- ① Rewind the tape up to the beginning of the saved data where the Pilot tone is previously recorded.
- ② Push the Tune/MIDI Button ④.
- ③ Push the lower side of the Parameter Button ⑧ once.

The Display shows "Memory Protect".

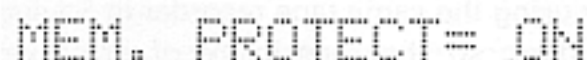

MEM. PROTECT= ON

- ④ Select "OFF" with the Value Button ⑨.
- ⑤ Push the Data Transfer Button ⑥.
- ⑥ Push the Parameter Button ⑧ until the Display shows "Tape Load".

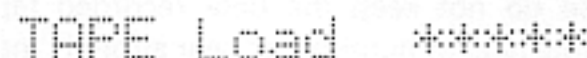

TAPE Load *****

- ⑦ Using the Value Button, select the data group to be loaded.
- ⑧ Push the Write Button ⑦.

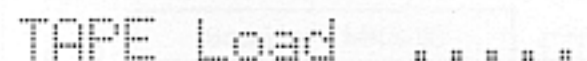

TAPE Load

- ⑨ Set the tape recorder to the playback mode and start the tape.

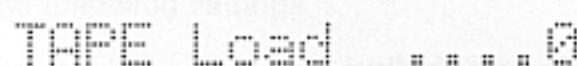

TAPE Load0

When the data head is found, 0 is shown, then the number increases as the loading is proceeding.

When the loading is completed, the Display responds with:

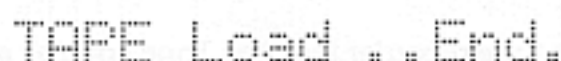

TAPE Load ..End.

- ▶ When the data cannot be loaded, "Load Error" is shown in the Display. Read "Note on the saving data on a tape" on page 48, then carefully repeat the loading procedure.

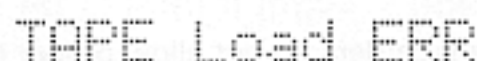

TAPE Load ERR

- ▶ When the Display shows "Mismatch Data", the data group to be loaded is different from the data group on the tape. Select the correct data group or change to the correct tape and repeat loading.

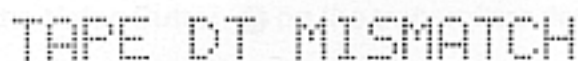

TAPE DT MISMATCH

- ⑩ Stop the tape recorder.
- ⑪ Set the Memory Protect to ON by taking the steps ② to ④.

■ Notes on saving onto a tape

When error indication is shown in the Display during verifying or loading operation, read the following notes then carefully repeat the saving or loading procedure.

▶ Tape rewinding

- * Make sure that you have rewound the tape completely up to the beginning of the saved data.

▶ Playback Level of the Tape Recorder

- * The appropriate playback level varies depending on the tape recorder. So change the level to find an appropriate level. Also, if your tape recorder features recording level control, try changing the recording level in saving.
- * If the tape recorder features Tone control, adjust it, too.

▶ Connection

- * Make sure that connections are made properly.
- * If your tape recorder has two kinds of In/Out Jacks (i.e. MIC/LINE In, EAR/LINE Out, etc), try using different ones this time.
- * Some tape recorders do not allow proper operation when both Save and Load connections are made at the same time. In such a case, make only the relevant connection.

▶ Where to start recording

- * Please do not start recording from the very head of the tape, but after slightly winding it.

▶ Tape you use

- * Use a new and high quality tape, if possible. An old tape is liable to have drop-out, therefore likely to cause error more often.
- * Use a cassette tape shorter than C-60. The one longer than C-90 is too thin for proper operation.

▶ Tape Recorder

- * Try using the same tape recorder in Saving and Loading, so that possibility of error will be reduced.
- * Clean and demagnetize the head of the tape recorder.

★ If error is still indicated, use a different tape recorder

* Preservation of the data tape

Please do not keep the data recorded tape in extreme heat or humidity or near strongly magnetic units such as TV, speaker or amplifier.

b. Bulk Dump/Bulk Load

Using the Roland MIDI Exclusive Messages, the data in the MKS-50 can be transferred to other MKS-50, and vice versa. Also, the Tone data of the MKS-50 can be copied to the Alpha Juno or the HS-80 and vice versa.

This copying function works whether "Exclusive" in the Patch Functions is set to ON or OFF.

There are two types of data transfer; handshake and one-way. Handshake allows to verify whether the receiver is ready to receive the data, while the one-way transmits the data without confirming the condition of the receiver. The MKS-50 can select either of the two methods.

Handshake Connection

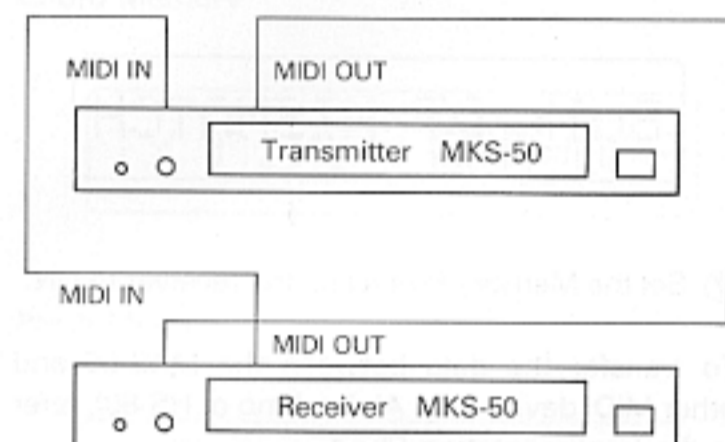

One-way Connection

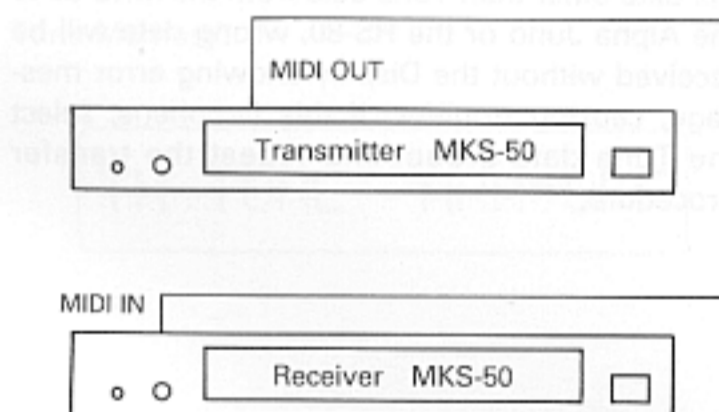

* Before taking the above procedure, set the MIDI channel of the receiver to the same number as the transmitter's.

«How to transfer the data between two MKS-50's»

- ① Set the Memory Protect of the receiver to OFF.
- ② Using the Parameter Button **8**, select either of the following settings.

Handshake setting:

Transmitter ▼

Bulk Dump *****

Receiver ▼

Bulk Load *****

One-way setting:

Transmitter ▼

Bulk*Dump *****

Receiver ▼

Bulk*Load *****

- ③ Select the data group to be transferred using the Value Button **9** on the transmitter device.
- ④ Select the same data group as selected on the transmitter as well as on the receiver by using the Value Button.

⑤ Push the Write Button ⑦ on the receiver.

The receiver is ready to receive the data.

Receiver ▼

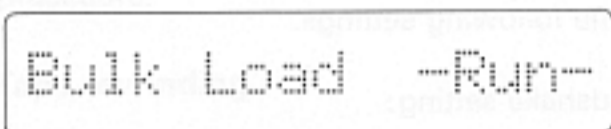

⑥ Push the Write Button on the transmitter.

The transmitter starts sending the data.

Transmitter ▼

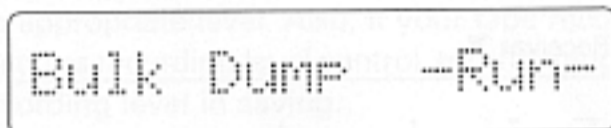

When the data transfer is completed, the Display responds with:

Transmitter ▼

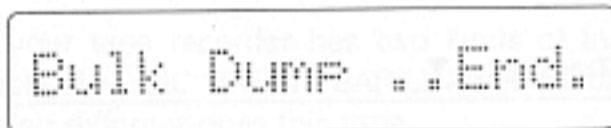

Receiver ▼

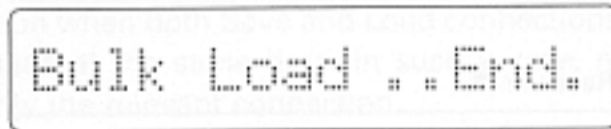

▶ When the data is not received, the receiver shows "Load Error". Check if the connections are correctly and securely made, then repeat the transferring procedure.

Receiver ▼

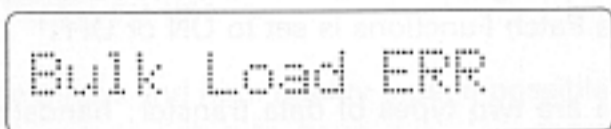

▶ When the Display shows "Mismatch Data", the data group to be transferred is different from the data group on the receiver. Select the correct data group and repeat the data transfer.

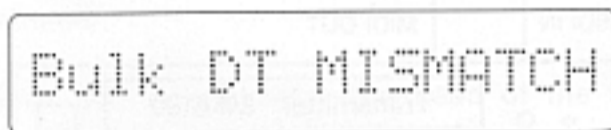

⑦ Set the Memory Protect on the receiver to ON.

To transfer the data between the MKS-50 and other MIDI device (e.g. Alpha Juno or HS-80), refer to the Implimentation Chart.

The Alpha Juno or the HS-80 cannot receive the data other than Tone data, but if you try to transfer the data other than Tone data from the MKS-50 to the Alpha Juno or the HS-80, wrong data will be received without the Display showing error message, causing troubles. If this happens, select the Tone data group, and repeat the transfer procedure.

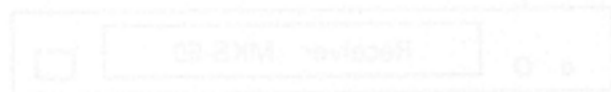

c. Transmitting only a part of data (External Editing)

Using the Roland Exclusive Message, it is possible to edit the data (e.g. a Patch Function, Tone Parameter or Chord Data) of the selected Patch.

For instance, by using the programmable machine such as the MC-500 (Micro composer) or computer, the data can be externally edited even during live performance.

* This function can be obtained only when "Exclusive" in the Patch Functions is set to ON.

- ① Push the Tune/MIDI Button ④.
- ② Using the Parameter Button ⑧, select the data group which is to be transmitted.

Chord Memory:

TX C.M. APR=OFF

Patch Memory:

TX PATCH APR=OFF

Tone Memory:

TX TONE APR=OFF

- ③ Using the Value Button ⑨, set the data group(s) to be transmitted to ON.
- ④ Select the Patch to be transmitted on the MKS-50.

The corresponding data will be transmitted.











When transmitting (editing) is completed, set all the data groups to OFF. (When the MKS-50 is turned off then turned on again, all the data groups will be automatically OFF.)

4 APPENDIX

1. Performance Controlling Function Table

Performanc Controlling Functions		Value	
Volume	Volume	00 — 127	
MOD. Sense	Modulation Sensitivity	00 — 127	
Portamento	Portamento	ON / OFF	
Porta. Time	Portamento Time	00 — 127	
Key Shift	Key Shift	-12 — +12	
Detune	Detune	-63 — +64	
Key Range Lo	Key Range Low	C0 — C8	
Key Range Hi	Key Range High	C8 — C0	
MIDI AFTER	MIDI Aftertouch	ON / OFF	
MIDI BENDER	MIDI Bender	ON / OFF	
MIDI EXCL	MIDI Exclusive	ON / OFF	
MIDI HOLD	MIDI Hold	ON / OFF	
MIDI MOD	MIDI Modulation	ON / OFF	
MIDI VOLUME	MIDI Volume	ON / OFF	
MIDI PORTA	MIDI Portamento	ON / OFF	
MONO BEND	Mono Bender Range	00 — 12	
CHORD MEM No.	Chord Memory Number	01 — 16	
ASSIGN MODE	Assign Mode	Poly Mono C.M.	Poly Mode Mono Mode Chord Memory

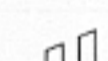
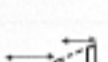
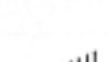



2. Parameter Table

Tone Parameter		Value	
DCO RNG	DCO Range	32' — 4'	
DCO LFO	DCO LFO Depth	00 — 127	
DCO ENV	DCO ENV Depth	00 — 127	
DCO ENV	DCO ENV Mode		Normal
			Invert
			Normal with Dynamics
			Invert with Dynamics
DCO AFTR	DCO Aftertouch Sensitivity	00 — 15	
DCO BEND	DCO Bender Range	00 — 12	
PULSE	DCO Pulse Waveform	00	OFF
		01	
		02	
		03	
SAWTOOTH	DCO Sawtooth Waveform	00	OFF
		01	
		02	
		03	
		04	
		05	

APPENDIX

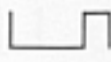
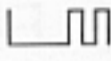
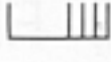
1. Performance Controlling Function Table

Table 1-1

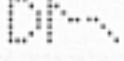
Tone Parameter		Value	
SUB	DCO Sub Oscillator Waveform	00	
		01	
		02	
		03	
		04	
		05	
SUB LEVEL	DCO Sub Oscillator Level	00 — 03	
NOIS LVL	DCO Noise Level	00 — 03	
PW/PWM	DCO PW/PWM Depth	00 — 127	
PWM RATE	DCO PWM Rate	00 — 127	
HPF FREQ	HPF Cutoff Frequency	00 — 03	
VCF FREQ	VCF Cutoff Frequency	00 — 127	
VCF RESO	VCF Resonance	00 — 127	
VCF ENV	VCF ENV Depth	00 — 127	
VCF ENV	VCF ENV Mode		Normal
			Invert
			Normal with Dynamics
		dyn	Dynamics
VCF LFO	VCF LFO Depth	00 — 127	
VCF KYBD	VCF Keyboard Follower	00 — 15	

Tone Parameter		Value	
UCF AFTR	Aftertouch Sensitivity	00 — 15	
VCA LEVEL	VCA Level	00 — 127	
VCA ENV	VCA ENV Mode	ENV	ENV
		GT	Gate
		DP	ENV with Dynamics
		DGT	Gate with Dynamics
VCA AFTR	VCA Aftertouch Sensitivity	00 — 15	
CHORUS	Chorus	ON / OFF	
CRS RATE	Chorus Rate	00 — 127	
LFO RATE	LFO Rate	00 — 127	
LFO DELY	LFO Delay Time	00 — 127	
ENV T1	ENV Time 1	00 — 127	
ENV L1	ENV Level 1	00 — 127	
ENV T2	ENV Time 2	00 — 127	
ENV L2	ENV Level 2	00 — 127	
ENV T3	ENV Time 3	00 — 127	
ENV L3	ENV Level 3	00 — 127	
ENV T4	ENV Time 4	00 — 127	
ENV KYBD	ENV Keyboard Follower	00 — 15	

3. Error Message Table

Display	Description
Check Battery!!	The battery for back-up memory is flat. * When this indication is shown, the data in the back-up memory may be lost. Consult with your local Roland dealer.
Memory Protected	You have tried to write into the back-up memory with the Memory Protect set to ON.
TAPE Load ERR	The data cannot be properly loaded from the tape.
TAPE Verify ERR	The data saved on the tape differs from the data in the MKS-50's memory.
TAPE DT MISMATCH	The data group saved on the tape differs from the data group in the MKS-50's memory.
Bulk Load ERR	The bulk dump data has not been completely received.
Bulk Dump ERR	The bulk dump data has not been completely received.
Bulk DT MISMATCH	The data group of the transmitter differs from that of the receiver.

4. SAMPLE NOTE

DATE : _____

● PATCH NAME _____

PROGRAMMER : _____

No. Bank	1	2	3	4	5	6	7	8
1								
2								
3								
4								
5								
6								
7								
8								

● TONE NAME _____

No. Bank	1	2	3	4	5	6	7	8
1								
2								
3								
4								
5								
6								
7								
8								

3. Error Message Table

DATE : _____

PROGRAMMER : _____

● PATCH NAME _____

No. Bank	1	2	3	4	5	6	7	8
1								
2								
3								
4								
5								
6								
7								
8								

● TONE NAME _____

No. Bank	1	2	3	4	5	6	7	8
1								
2								
3								
4								
5								
6								
7								
8								

DATE : _____

PROGRAMMER : _____

● PATCH NAME

No. Bank	1	2	3	4	5	6	7	8
1								
2								
3								
4								
5								
6								
7								
8								

● TONE NAME

No. Bank	1	2	3	4	5	6	7	8
1								
2								
3								
4								
5								
6								
7								
8								

4. Quick Operation Table

A. Patch Selection

PATCH A ↔ B	1	2	3	4
	5	6	7	8

B. Tuning

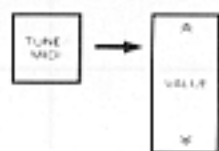

C. Editing a Tone Number



D. Editing a Function

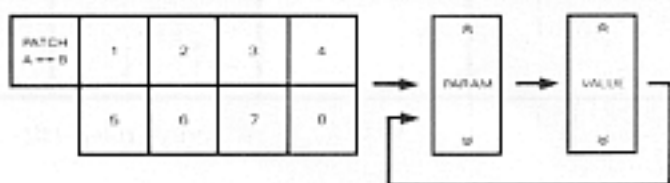

E. Writing a Patch

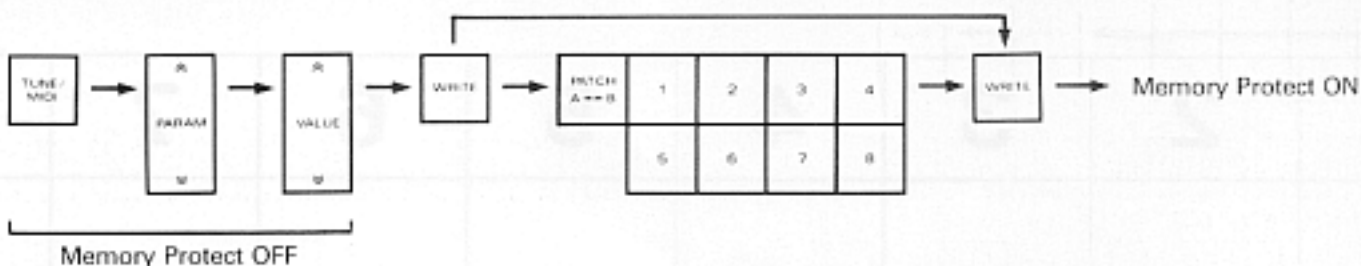

F. Editing a Tone Parameter

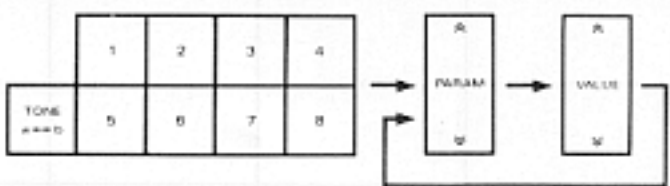

G. Writing a Tone

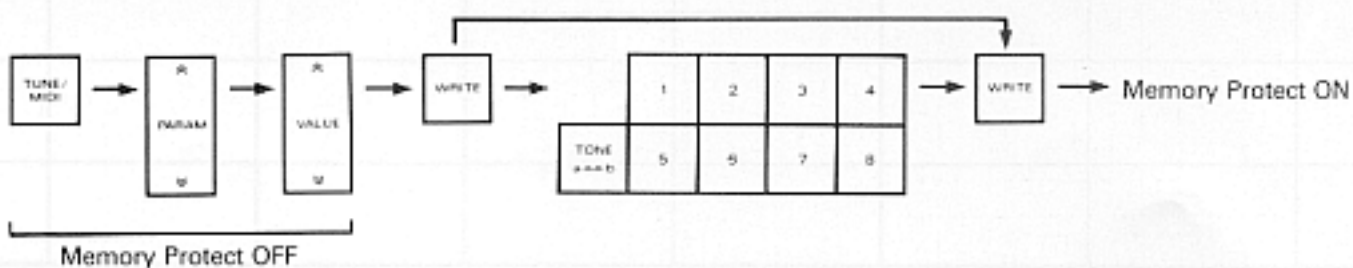

H. Naming

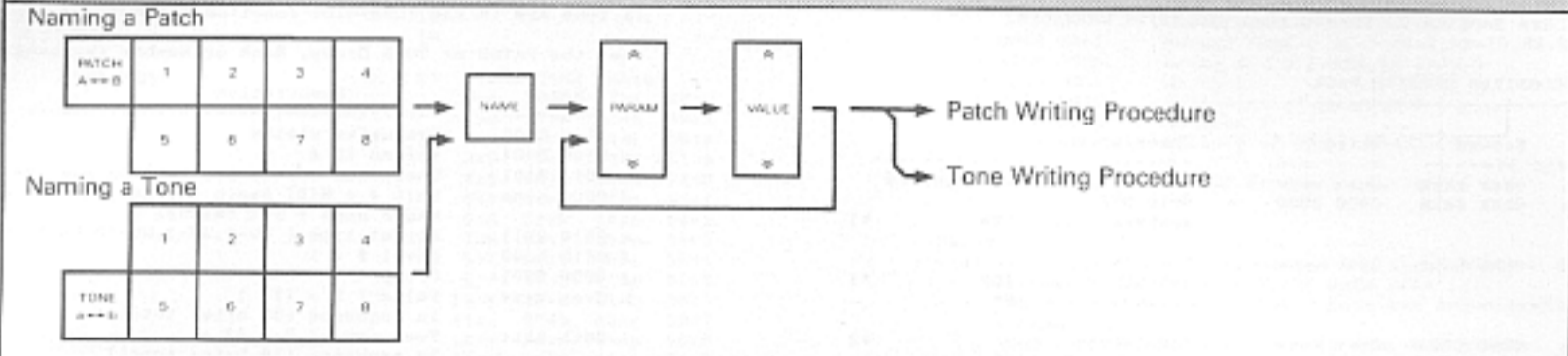

I. Playing a Chord Memory

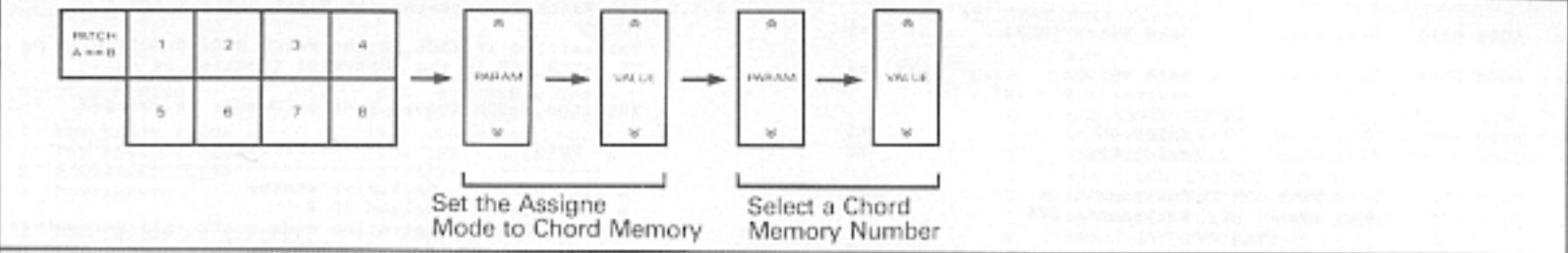

J. Writing a Chord Memory

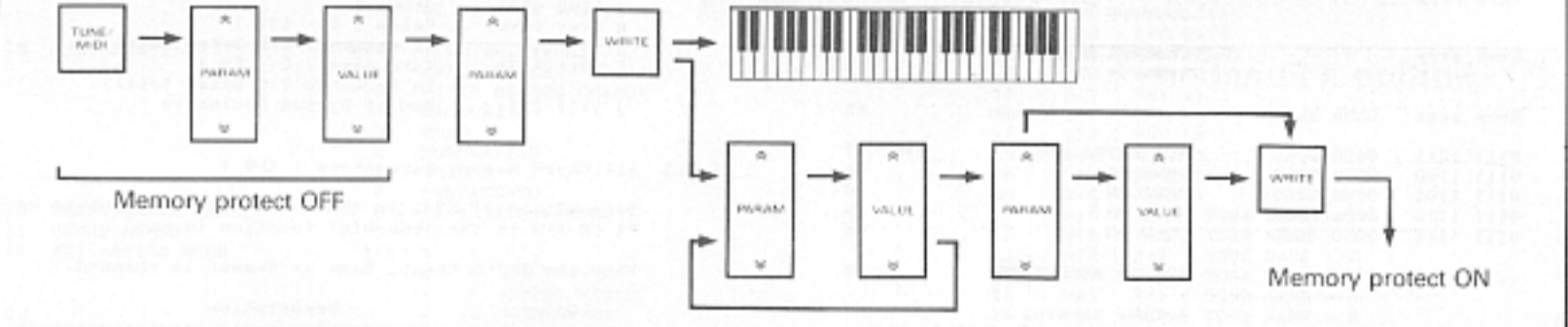

K. Mode Selection

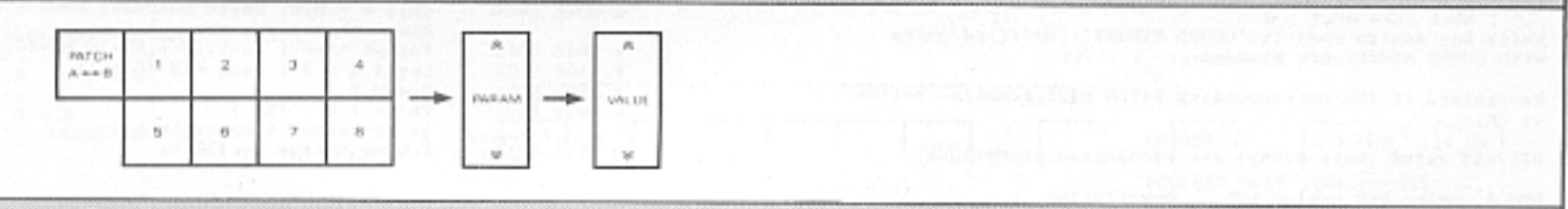

L. Saving and Transfer

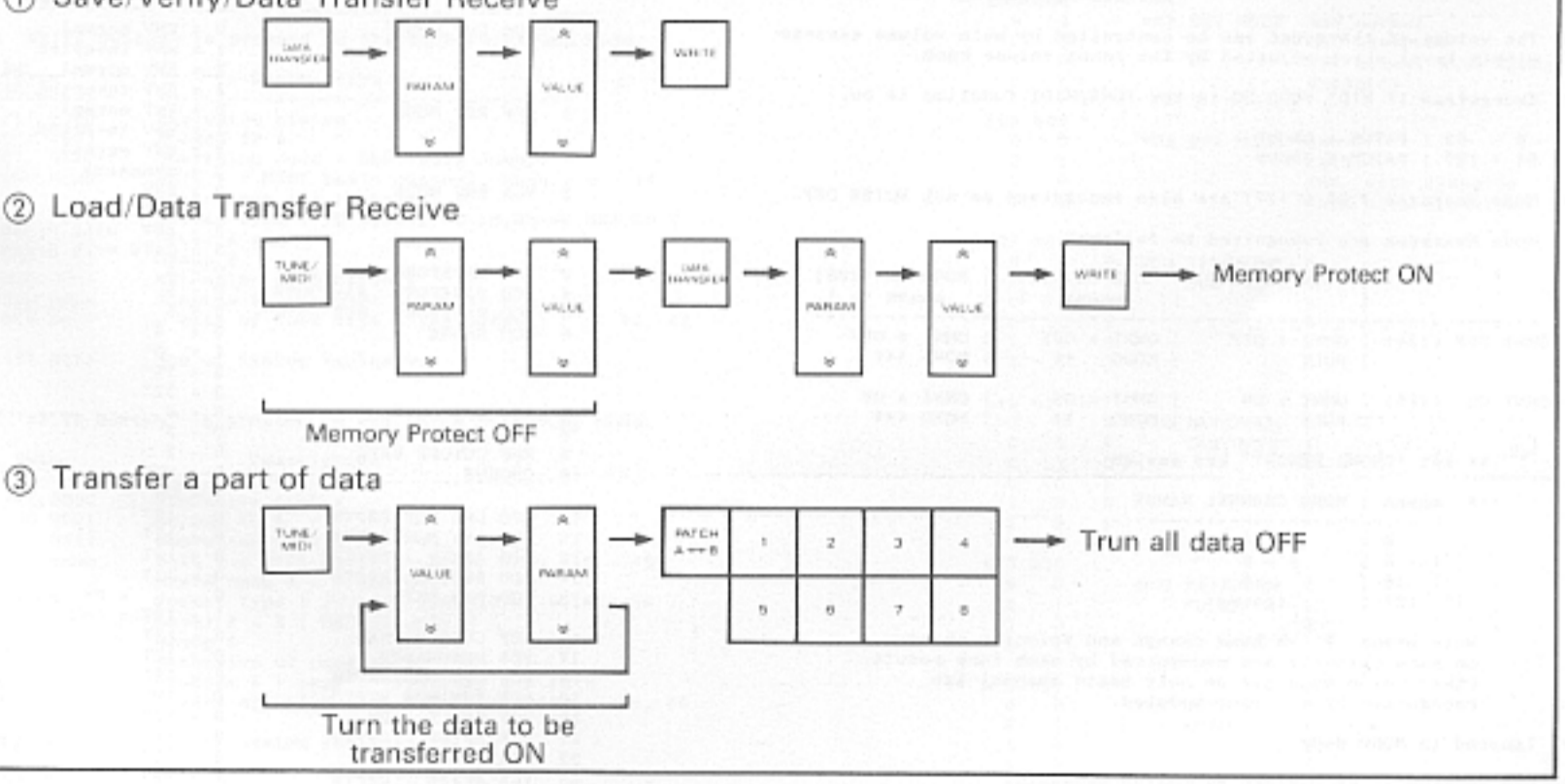

MODEL MKS-50 MIDI Implementation

1. TRANSMITTED DATA

Status	Second	Third	Description
1111 0000	1111 0111	SYSTEM EXCLUSIVE
Note : See Section 3. TRANSMITTED EXCLUSIVE MESSAGES.			
1000 nnnn	Okkk kkkk	0vvv vvvv	Note OFF, velocity ignored
1001 nnnn	Okkk kkkk	0000 0000	Note OFF kkkkkkk = 12 - 108 *1
1001 nnnn	Okkk kkkk	0vvv vvvv	Note ON kkkkkkk = 12 - 108 *1 vvvvvvv = 1 - 127
1011 nnnn	0000 0001	0vvv vvvv	Modulation vvvvvvv = 0 - 127 *2
1011 nnnn	0000 0101	0vvv vvvv	Portamento Time vvvvvvv = 0 - 127 *2
1011 nnnn	0000 0110	0vvv vvvv	Data Entry (MSB) *3
1011 nnnn	0000 0111	0vvv vvvv	Main volume vvvvvvv = 0 - 127 *2, *4
1011 nnnn	0100 0000	01xx xxxx	Hold1 ON *2
1011 nnnn	0100 0000	00xx xxxx	Hold1 OFF *2
1011 nnnn	0100 0001	01xx xxxx	Portamento ON *2
1011 nnnn	0100 0001	00xx xxxx	Portamento OFF *2
1011 nnnn	0110 0100	0000 0000	RPC (LSB) *3
1011 nnnn	0110 0101	0000 0000	RPC (MSB) *3
1100 nnnn	0ppp pppp		Program Change ppppppp = 0 - 127 *5
1101 nnnn	0vvv vvvv		Channel After Touch vvvvvvv = 0 - 127 *2
1110 nnnn	0bbx xxxx	0bbb bbbb	Pitch Bend Change *2
1011 nnnn	0111 1011	0000 0000	ALL NOTES OFF *6, *7
1011 nnnn	0111 1100	0000 0000	OMNI OFF *6
1011 nnnn	0111 1101	0000 0000	OMNI ON *6
1011 nnnn	0111 1110	0000 0000	MONO ON *6
1011 nnnn	0111 1111	0000 0000	POLY ON *6
1111 0000	1111 0111	SYSTEM EXCLUSIVE *8
1111 1110			Active Sensing

Notes :

*1 Note numbers outside the range 12 - 108 are transposed to the nearest octave inside this range.

While key assign mode is 'CHORD MEMORY', modified notes with CHORD MEMORY are sounded.

*2 Recognized if the corresponding PATCH MIDI function switch is ON.

*3 RPC and value (Data Entry) are recognized as follows.

RPC #	value MSB	value LSB	Description
0	0vvv vvvv	0xxx xxxx	BEND RANGE (0-24 semitone, 1 semitone step) xxxxxxx is ignored.

*4 The volume of the sound can be controlled by main volume message within level which adjusted by the panel volume knob.

*5 Recognized if MIDI PROG.CG in the TUNE/MIDI function is on.

0 - 63 : PATCH-A GROUP
64 - 127 : PATCH-B GROUP

*6 Mode Messages (123 - 127) are also recognized as ALL NOTES OFF.

Mode Messages are recognized as follows:

	: POLY ON (127)	: MONO ON (126)	: MONO ON (125)
		: mmmmm = 1	: mmmmm () 1
OMNI OFF (124)	: OMNI = OFF	: OMNI = OFF	: OMNI = OFF
	: POLY	: MONO **	: MONO ***
OMNI ON (125)	: OMNI = ON	: OMNI = ON	: OMNI = ON
	: POLY	: MONO **	: MONO ***

** set 'CHORD MEMORY' key assign

*** nnnnn	MONO CHANNEL RANGE
0	6
1 - 6	1 - 6
7 - 16	6
17 - 127	ignore

Note event, Pitch bend change and Velocity change on each channels are recognized by each tone module. Other voice messages on only basic channel are recognized by all tone modules.

*7 Ignored in MONO mode.

*8 See Section 4. RECOGNIZED EXCLUSIVE MESSAGES.

3. TRANSMITTED EXCLUSIVE MESSAGES

3.1 All Parameters (APR)

3.1.1 All Tone Parameters with Tone names (APR)

Transmitted if EXCL in the PATCH MIDI function is on and TX TONE APR in the TUNE/MIDI function is on.

When the PATCH or TONE Group, Bank or Number is changed.

Byte	Description
a 1111 0000	Exclusive status
b 0100 0001	Roland ID #
c 0011 0101	Operation code = APR (all parameters)
d 0000 nnnn	Unit # = MIDI basic channel, nnnn = 0 - 15 where nnnn + 1 = channel #
e 0010 0011	Format type (JU-1, JU-2, HS-10, HS-80, MKS-50)
f 0010 0000	Level # = 1
g 0000 0001	Group #
h 0vvv vvvv	Value (0 - 127) *1
:	In sequence (36 bytes total)
i 00tt tttt	Tone name (0 - 63)
:	In sequence (10 bytes total)
j 1111 0111	End of System Exclusive

3.1.2 All Patch Parameters with Patch names (APR)

Transmitted if EXCL in the PATCH MIDI function is on and TX PATCH APR in the TUNE/MIDI function is on.

When the PATCH Group, Bank or Number is changed.

Byte	Description
a 1111 0000	Exclusive status
b 0100 0001	Roland ID #
c 0011 0101	Operation code = APR (all parameters)
d 0000 nnnn	Unit # = MIDI basic channel, nnnn = 0 - 15 where nnnn + 1 = channel #
e 0010 0011	Format type (JU-1, JU-2, HS-10, HS-80, MKS-50)
f 0011 0000	Level # = 2 (used MKS-50 only)
g 0000 0001	Group #
h 0vvv vvvv	Value (0 - 127) *2
:	In sequence (13 bytes total)
i 00tt tttt	Tone name (0 - 63)
:	In sequence (10 bytes total)
j 1111 0111	End of System Exclusive

3.1.3 All Chord Memory Parameters (APR)

Transmitted if EXCL in the PATCH MIDI function is on and TX CM APR in the TUNE/MIDI function is on.

When the PATCH Group, Bank or Number is changed.

Byte	Description
a 1111 0000	Exclusive status
b 0100 0001	Roland ID #
c 0011 0101	Operation code = APR (all parameters)
d 0000 nnnn	Unit # = MIDI basic channel, nnnn = 0 - 15 where nnnn + 1 = channel #
e 0010 0011	Format type (JU-1, JU-2, HS-10, HS-80, MKS-50)
f 0100 0000	Level # = 3 (used MKS-50 only)
g 0000 0001	Group #
h 0vvv vvvv	Value (0 - 127) *3
:	In sequence (6 bytes total)
j 1111 0111	End of System Exclusive

Notes :

*1 Tone Parameter

#	Function	Value
0	DCO ENV MODE	0 = ENV normal 1 = ENV inverted 2 = ENV normal with dynamics 3 = ENV inverted with dynamics
1	VCF ENV MODE	0 = ENV normal 1 = ENV inverted 2 = ENV normal with dynamics 3 = dynamics
2	VCA ENV MODE	0 = ENV 1 = GATE 2 = ENV with dynamics 3 = GATE with dynamics
3	DCO WAVEFORM PULSE	0 - 3
4	DCO WAVEFORM SAWTOOTH	0 - 5
5	DCO WAVEFORM SUB	0 - 5
6	DCO RANGE	0 = 4' 1 = 8' 2 = 16' 3 = 32'
7	DCO SUB LEVEL	0 - 3
8	DCO NOISE LEVEL	0 - 3
9	HPF CUTOFF FREQ	0 - 3
10	CHORUS	0 = OFF 1 = ON
11	DCO LFO MOD DEPTH	0 - 127
12	DCO ENV MOD DEPTH	0 - 127
13	DCO AFTER DEPTH	0 - 127
14	DCO PW/PWM DEPTH	0 - 127
15	DCO PWM RATE	0 = PW manual 1 - 127 = PWM LFO RATE
16	VCF CUTOFF FREQ	0 - 127
17	VCF RESONANCE	0 - 127
18	VCF LFO MOD DEPTH	0 - 127
19	VCF ENV MOD DEPTH	0 - 127
20	VCF KEY FOLLOW	0 - 127
21	VCF AFTER DEPTH	0 - 127
22	VCA LEVEL	0 - 127
23	VCA AFTER DEPTH	0 - 127
24	LFO RATE	0 - 127
25	LFO DELAY TIME	0 - 127

26	ENV T1	0 - 127 (ATTACK TIME)
27	ENV L1	0 - 127 (ATTACK LEVEL)
28	ENV T2	0 - 127 (BREAK TIME)
29	ENV L2	0 - 127 (BREAK LEVEL)
30	ENV T3	0 - 127 (DECAY TIME)
31	ENV L3	0 - 127 (SUSTAIN LEVEL)
32	ENV T4	0 - 127 (RELEASE TIME)
33	ENV KEY FOLLOW	0 - 127
34	CHORUS RATE	0 - 127
35	BENDER RANGE	0 - 12
36 - 45	TONE NAME	0 - 63 (TONE NAME table)

0=A 16=Q 32=g 48=w
1=B 17=R 33=h 49=x
2=C 18=S 34=i 50=y
3=D 19=T 35=j 51=z
4=K 20=U 36=k 52=0
5=F 21=V 37=l 53=1
6=G 22=W 38=m 54=2
7=H 23=X 39=n 55=3
8=I 24=Y 40=o 56=4
9=J 25=Z 41=p 57=5
10=K 26=a 42=q 58=6
11=L 27=b 43=r 59=7
12=M 28=c 44=s 60=8
13=N 29=d 45=t 61=9
14=O 30=e 46=u 62=space
15=P 31=f 47=v 63=-

3.2.3 When 'WRITE Button' is pressed in the CM Bulk*Dump Mode.

Byte	Description
a 1111 0000	Exclusive status
b 0100 0001	Roland ID #
c 0011 0111	Operation code = BLD (bulk dump)
d 0000 nnnn	Unit # = MIDI basic channel, nnnn = 0 - 15 where nnnn + 1 = channel #
e 0010 0011	Format type (JU-1, JU-2, HS-10, HS-80, MKS-50)
f 0100 0000	Level # = 3 (MKS-50 only)
g 0000 0001	Group #
h 0000 0000	Extension of program #
i 0000 0000	Program #
j 0000 vvvv	16 sets of CHORD MEMORY data (192 bytes) #4
k 1111 0111	End of System Exclusive

Notes:
#1 The Program # (i) represents the first TONE or PATCH number of the TONE or PATCH data sets (j). The 4 sets of TONE or PATCH data are sequentially transmitted. TONE or PATCH data is sent in four-bit nibbles, right justified, least significant nibble sent first. Each TONE or PATCH data consists of 32 bytes. The Bulk Dump message repeats 16 times.

#2 Patch Parameter

#	Function	Value
0	TONE NUMBER	0 - 63 TONE-a Group 64 - 127 TONE-b Group
1	KEY RANGE (LOW)	12 - 108 (note no.)
2	KEY RANGE (HIGH)	13 - 109 (note no.)
3	PORTAMENTO TIME	0 - 127
4	PORTAMENTO	0 = OFF 1 = ON
5	MODULATION SENSITIVITY	0 - 127
6	KEY SHIFT	0 - 12 (+ 12 semitone) 127 - 116 (- 12 semitone)
7	VOLUME	0 - 127
8	DETUNE	0 - 63 (+ 25 cent) 127 - 65 (- 25 cent)
9	MIDI FUNCTION	bit (0 = on, 1 = off) 6 AFTER TOUCH 5 PITCH BENDER CHANGE 4 EXCLUSIVE 3 HOLD 2 MODULATION 1 VOLUME 0 PORTAMENTO
10	MONO BENDER RANGE	0 - 12 (12 semitone)
11	CHORD MEMORY	0 - 15
12	KEY ASSIGN MODE	bit 6 5 0 0 POLY MODE 1 0 CHORD MEMORY 1 1 MONO MODE bit 4 - 0 ignored
13 - 22	PATCH NAME	0 - 63 (see TONE NAME table)

#3 Chord parameter

#	Function	Value
0 - 5	CHORD NOTE NO.	36 - 84 (sounded note) 127 (dummy)

3.2 Bulk Dump (BLD)

*Bulk Dump has no relation with the EXCL in the PATCH MIDI function.

3.2.1 When 'WRITE Button' is pressed in the TONE Bulk*Dump Mode.

Byte	Description
a 1111 0000	Exclusive status
b 0100 0001	Roland ID #
c 0011 0111	Operation code = BLD (bulk dump)
d 0000 nnnn	Unit # = MIDI basic channel, nnnn = 0 - 15 where nnnn + 1 = channel #
e 0010 0011	Format type (JU-1, JU-2, HS-10, HS-80, MKS-50)
f 0011 0000	Level # = 1
g 0000 0001	Group #
h 0000 0000	Extension of program #
i 00pp pppp	Program # (pppppp= n#4 : n= 0 - 15)
j 0000 vvvv	4 sets of TONE data (256 bytes) #1, #2
k 1111 0111	End of System Exclusive

3.2.2 When 'WRITE Button' is pressed in the PATCH Bulk*Dump Mode.

Byte	Description
a 1111 0000	Exclusive status
b 0100 0001	Roland ID #
c 0011 0111	Operation code = BLD (bulk dump)
d 0000 nnnn	Unit # = MIDI basic channel, nnnn = 0 - 15 where nnnn + 1 = channel #
e 0010 0011	Format type (JU-1, JU-2, HS-10, HS-80, MKS-50)
f 0011 0000	Level # = 2 (MKS-50 only)
g 0000 0001	Group #
h 0000 0000	Extension of program #
i 00pp pppp	Program # (pppppp= n#4 : n= 0 - 15)
j 0000 vvvv	4 sets of PATCH data (256 bytes) #1, #3
k 1111 0111	End of System Exclusive

#2 TONE data format

byte	msb	7	6	5	4	3	2	1	0	lsb
0	:	DCO AFTER DEPTH	:	VCF KEY FOLLOW	:	:	:	:	:	:
1	:	VCF AFTER DEPTH	:	VCA AFTER DEPTH	:	:	:	:	:	:
2	:	ENV KEY FOLLOW	:	DCO BENDER RANGE	:	:	:	:	:	:
3	:	***	:	DCO LFO MOD DEPTH	:	:	:	:	:	:
4	:	b00	:	DCO ENV MOD DEPTH	:	:	:	:	:	:
5	:	b01	:	DCO PULSE PW/PWM DEPTH	:	:	:	:	:	:
6	:	b02	:	DCO PWM RATE	:	:	:	:	:	:
7	:	b03	:	VCF CUTOFF FREQ	:	:	:	:	:	:
8	:	b04	:	VCF RESONANCE	:	:	:	:	:	:
9	:	b05	:	VCF ENV MOD DEPTH	:	:	:	:	:	:
10	:	b06	:	VCF LFO MOD DEPTH	:	:	:	:	:	:
11	:	b07	:	VCA LEVEL	:	:	:	:	:	:
12	:	b08	:	LFO RATE	:	:	:	:	:	:
13	:	b09	:	LFO DELAY	:	:	:	:	:	:
14	:	b10	:	ENV T1	:	:	:	:	:	:
15	:	b11	:	ENV L1	:	:	:	:	:	:
16	:	b12	:	ENV T2	:	:	:	:	:	:
17	:	b13	:	ENV L2	:	:	:	:	:	:
18	:	b14	:	ENV T3	:	:	:	:	:	:
19	:	b15	:	ENV L3	:	:	:	:	:	:
20	:	b16	:	ENV T4	:	:	:	:	:	:
21	:	b17	:	***	:	:	:	:	:	:
22	:	b18	:	***	:	:	:	:	:	:
23	:	b19	:	***	:	:	:	:	:	:
24	:	b20	:	***	:	:	:	:	:	:
25	:	b21	:	***	:	:	:	:	:	:
26	:	b22	:	***	:	:	:	:	:	:
27	:	c 1	:	c 0	:	:	:	:	:	:
28	:	c 3	:	c 2	:	:	:	:	:	:
29	:	c 5	:	c 4	:	:	:	:	:	:
30	:	c 7	:	c 6	:	:	:	:	:	:
31	:	:	:	:	:	:	:	:	:	:

*** : 0, ignored if received

Switch bit

bit	bit	Function	0	1
b00		CHORUS	0 = OFF	1 = ON
b01	b02	DCO ENV MODE	ENV normal	ENV inverted
			ENV normal with dynamics	ENV inverted with dynamics
b03	b04	VCF ENV MODE	ENV normal	ENV inverted
			ENV normal with dynamics	dynamics
b05	b06	VCA ENV MODE	ENV	GATE
			ENV with dynamics	GATE with dynamics
b07	b08	b09	DCO WAVEFORM	0
			SUB	1
				2
				3
				4
				5
b10	b11	b12	DCO WAVEFORM	0
			SANTOOTH	1
				2
				3
				4
				5
b13	b14	DCO WAVEFORM	0	
		PULSE	1	
			2	
			3	
b15	b16	HPF CUTOFF	0	
		FREQ	1	
			2	
			3	

b17 b18	DCO RANGE	4'
0 0		4'
0 1		8'
1 0		16'
1 1		32'
b19 b20	DCO SUB LEVEL	0
0 0		0
0 1		1
1 0		2
1 1		3
b21 b22	DCO NOISE LEVEL	0
0 0		0
0 1		1
1 0		2
1 1		3

c7 c6 c5 c4 c3 c2 c1 c0
 0 v v v v v v v v CHORUS RATE
 vvvvvvv = 0 - 127

*3 PATCH data format

msb	lab
byte	7 : 6 : 5 : 4 : 3 : 2 : 1 : 0
0	TONE NUMBER
1	KEY RANGE LOW
2	KEY RANGE HIGH
3	PORTAMENTO TIME
4	MODULATION SENSITIVITY
5	KEY SHIFT
6	VOLUME
7	DETUNE
8	MONO BENDER RANGE ; CHORD MEMORY NO.
9	MIDI FUNCTION
10	b00 : b01 : b02 : b03 : 0 : 0 : 0 : 0
11	*** : *** : PATCH NAME - 1
12	*** : *** : PATCH NAME - 2
13	*** : *** : PATCH NAME - 3
14	*** : *** : PATCH NAME - 4
15	*** : *** : PATCH NAME - 5
16	*** : *** : PATCH NAME - 6
17	*** : *** : PATCH NAME - 7
18	*** : *** : PATCH NAME - 8
19	*** : *** : PATCH NAME - 9
20	*** : *** : PATCH NAME - 10
21	0
22	0
23	0
24	0
25	0
26	0
27	0
28	0
29	0
30	0
31	10 (PATCH DATA code)

*** : 0, ignored if received

Switch bit

b00	EXP.MODE	0 = NORMAL 1 = EXP.
b01 b02	KEY ASSIGN MODE	POLY
0 0		CHORD MEMORY
1 0		MONO (6 voice range)
1 1		
b03	PORTAMENTO	0 = OFF 1 = ON

*4 CHORD MEMORY data is sent in four-bit nibbles, right justified, least significant nibble sent first. (6 bytes/(one CHORD MEMORY data) * 16 = 96 bytes)

RECOGNIZED EXCLUSIVE MESSAGES

1 All Parameters (APR)

*Received if EXCL in the PATCH MIDI function is on.

1.1 All Tone Parameters with Tone names (APR)

Byte	Description
a 1111 0000	Exclusive status
b 0100 0001	Roland ID #
c 0011 0101	Operation code = APR (all parameters)
d 0000 nnnn	Unit # = MIDI basic channel, nnnn = 0 - 15 where nnnn + 1 = channel #
e 0010 0011	Format type (JU-1, JU-2, HS-10, HS-80, MKS-50)
f 0010 0000	Level # = 1
g 0000 0001	Group #
h 00vv vvvv	Value (0 - 127) *1
:	In sequence (36 bytes total)
i 00tt tttt	Tone name (0 - 63)
:	In sequence (10 bytes total)
j 1111 0111	End of System Exclusive

1.2 All Tone Parameters without Tone names (APR)

Byte	Description
a 1111 0000	Exclusive status
b 0100 0001	Roland ID #
c 0011 0101	Operation code = APR (all parameters)
d 0000 nnnn	Unit # = MIDI basic channel, nnnn = 0 - 15 where nnnn + 1 = channel #
e 0010 0011	Format type (JU-1, JU-2, HS-10, HS-80, MKS-50)
f 0010 0000	Level # = 1
g 0000 0001	Group #
h 00vv vvvv	Value (0 - 127) *1
:	In sequence (36 bytes total)
i 1111 0111	End of System Exclusive

4.1.3 Individual Tone Parameter (IPR)

Byte	Description
a 1111 0000	Exclusive status
b 0100 0001	Roland ID #
c 0011 0110	Operation code = IPR (individual parameter)
d 0000 nnnn	Unit # = MIDI basic channel, nnnn = 0 - 15 where nnnn + 1 = channel #
e 0010 0011	Format type (JU-1, JU-2, HS-10, HS-80, MKS-50)
f 0010 0000	Level # = 1
g 0000 0001	Group #
h 00pp pppp	Parameter # (0 - 35) *1
i 00vv vvvv	Value (0 - 127)
:	h and i (repetitively)
j 1111 0111	End of System Exclusive

4.1.4 All Patch Parameters with Patch names (APR)

Byte	Description
a 1111 0000	Exclusive status
b 0100 0001	Roland ID #
c 0011 0101	Operation code = APR (all parameters)
d 0000 nnnn	Unit # = MIDI basic channel, nnnn = 0 - 15 where nnnn + 1 = channel #
e 0010 0011	Format type (JU-1, JU-2, HS-10, HS-80, MKS-50)
f 0011 0000	Level # = 2 (used MKS-50 only)
g 0000 0001	Group #
h 00vv vvvv	Value (0 - 127) *2
:	In sequence (13 bytes total)
i 00tt tttt	Tone name (0 - 63)
:	In sequence (10 bytes total)
j 1111 0111	End of System Exclusive

4.1.5 Individual Patch Parameter (IPR)

Byte	Description
a 1111 0000	Exclusive status
b 0100 0001	Roland ID #
c 0011 0110	Operation code = IPR (individual parameter)
d 0000 nnnn	Unit # = MIDI basic channel, nnnn = 0 - 15 where nnnn + 1 = channel #
e 0010 0011	Format type (JU-1, JU-2, HS-10, HS-80, MKS-50)
f 0011 0000	Level # = 2 (MKS-50 only)
g 0000 0001	Group #
h 0000 pppp	Parameter # (0 - 12) *2
i 00vv vvvv	Value (0 - 127)
:	h and i (repetitively)
j 1111 0111	End of System Exclusive

4.1.6 All Chord Memory Parameters (APR)

Byte	Description
a 1111 0000	Exclusive status
b 0100 0001	Roland ID #
c 0011 0101	Operation code = APR (all parameters)
d 0000 nnnn	Unit # = MIDI basic channel, nnnn = 0 - 15 where nnnn + 1 = channel #
e 0010 0011	Format type (JU-1, JU-2, HS-10, HS-80, MKS-50)
f 0100 0000	Level # = 3 (used MKS-50 only)
g 0000 0001	Group #
h 00vv vvvv	Value (0 - 127) *3
:	In sequence (6 bytes total)
j 1111 0111	End of System Exclusive

Notes :

- *1 See Tone Parameter in 3.1 All Parameter (APR)
- *2 See Patch Parameter in 3.1 All Parameter (APR)
- *3 See Chord Parameter in 3.1 All Parameter (APR)

4.2 Bulk Dump (BLD)

*Bulk Dump has no relation with the EXCL in the PATCH MIDI function.

4.2.1 When 'WRITE Button' is pressed in the TONE Bulk*Load Mode.

Byte	Description
a 1111 0000	Exclusive status
b 0100 0001	Roland ID #
c 0011 0111	Operation code = BLD (bulk dump)
d 0000 nnnn	Unit # = MIDI basic channel, nnnn = 0 - 15 where nnnn + 1 = channel #
e 0010 0011	Format type (JU-1, JU-2, HS-10, HS-80, MKS-50)
f 0010 0000	Level # = 1
g 0000 0001	Group #
h 0000 0000	Extension of program #
i 00pp pppp	Program #
j 0000 tttt	Some sets of TONE data *1, *2
:	
k 1111 0111	End of System Exclusive

4.2.2 When 'WRITE Button' is pressed in the PATCH Bulk*Load Mode.

Byte	Description
a 1111 0000	Exclusive status
b 0100 0001	Roland ID #
c 0011 0111	Operation code = BLD (bulk dump)
d 0000 nnnn	Unit # = MIDI basic channel, nnnn = 0 - 15 where nnnn + 1 = channel #
e 0010 0011	Format type (JU-1, JU-2, HS-10, HS-80, MKS-50)
f 0011 0000	Level # = 2 (MKS-50 only)
g 0000 0001	Group #
h 0000 0000	Extension of program #
i 00pp pppp	Program #
j 0000 vvvv	same set of PATCH data *1, *3
:	
k 1111 0111	End of System Exclusive

4.2.3 When 'WRITE Button' is pressed in the CM BulkLoad Mode.

Byte	Description
a 1111 0000	Exclusive status
b 0100 0001	Roland ID #
c 0011 0111	Operation code = BLD (bulk dump)
d 0000 nnnn	Unit # = MIDI basic channel, nnnn = 0 - 15 where nnnn + 1 = channel #
e 0010 0011	Format type (JU-1, JU-2, HS-10, HS-80, MKS-50)
f 0100 0000	Level # = 3 (MKS-50 only)
g 0000 0001	Group #
h 0000 0000	Extension of program #
i 0000 0000	Program #
j 0000 vvvv	16 sets of CHORD MEMORY data (192 bytes) *3
k 1111 0111	End of System Exclusive

- Notes :
- *1 The Program # is recognized as the first TONE or PATCH number of the TONE or PATCH data sets. 32 bytes are recognized as a set of TONE or PATCH data. TONE or PATCH data is received in four-bit nibbles, right justified, least significant nibble received first.
 - *2 See 3.2 Bulk Dump, to understand the TONE data format.
 - *3 See 3.2 Bulk Dump, to understand the PATCH data format.
 - *4 See 3.2 Bulk Dump, to understand the CHORD MEMORY data format.

HANDSHAKING COMMUNICATION

1. Message Type

5.1.1 Want to send a file (WSF)

Byte	Description
a 1111 0000	Exclusive status
b 0100 0001	Roland ID #
c 0100 0000	Operation code = WSF
d 0000 nnnn	Unit # = MIDI basic channel, nnnn = 0 - 15 where nnnn + 1 = channel #
e 0010 0011	Format type (JU-1, JU-2, HS-10, HS-80, MKS-50)
f 1111 0111	End of System Exclusive

5.1.2 Request a file (RQF)

Byte	Description
a 1111 0000	Exclusive status
b 0100 0001	Roland ID #
c 0100 0001	Operation code = RQF
d 0000 nnnn	Unit # = MIDI basic channel, nnnn = 0 - 15 where nnnn + 1 = channel #
e 0010 0011	Format type (JU-1, JU-2, HS-10, HS-80, MKS-50)
f 1111 0111	End of System Exclusive

5.1.3 Data (DAT)

Byte	Description
a 1111 0000	Exclusive status
b 0100 0001	Roland ID #
c 0100 0010	Operation code = DAT
d 0000 nnnn	Unit # = MIDI basic channel, nnnn = 0 - 15 where nnnn + 1 = channel #
e 0010 0011	Format type (JU-1, JU-2, HS-10, HS-80, MKS-50)
f 0000 tttt	4 sets of TONE or PATCH data (256 bytes), CHORD MEMORY data (192 bytes)
g 0sss ssss	Check sum
h 1111 0111	End of System Exclusive

- Notes :
- Each data are sent in four-bit nibbles, right justified, least significant nibble sent first.
 - PATCH or CHORD MEMORY data is valid only for MKS-50.
 - See 3.2 Bulk Dump, to understand each data format.
 - Summed value of the all bytes in data and the check sum must be 0 (7bits).

5.1.4 Acknowledge (ACK)

Byte	Description
a 1111 0000	Exclusive status
b 0100 0001	Roland ID #
c 0100 0011	Operation code = ACK
d 0000 nnnn	Unit # = MIDI basic channel, nnnn = 0 - 15 where nnnn + 1 = channel #
e 0010 0011	Format type (JU-1, JU-2, HS-10, HS-80, MKS-50)
f 1111 0111	End of System Exclusive

5.1.5 End of file (EOF)

Byte	Description
a 1111 0000	Exclusive status
b 0100 0001	Roland ID #
c 0100 0101	Operation code = EOF
d 0000 nnnn	Unit # = MIDI basic channel, nnnn = 0 - 15 where nnnn + 1 = channel #
e 0010 0011	Format type (JU-1, JU-2, HS-10, HS-80, MKS-50)
f 1111 0111	End of System Exclusive

5.1.6 Communication error (ERR)

Byte	Description
a 1111 0000	Exclusive status
b 0100 0001	Roland ID #
c 0100 1110	Operation code = ERR
d 0000 nnnn	Unit # = MIDI basic channel, nnnn = 0 - 15 where nnnn + 1 = channel #
e 0010 0011	Format type (JU-1, JU-2, HS-10, HS-80, MKS-50)
f 1111 0111	End of System Exclusive

5.1.7 Rejection (RJC)

Byte	Description
a 1111 0000	Exclusive status
b 0100 0001	Roland ID #
c 0100 1111	Operation code = RJC
d 0000 nnnn	Unit # = MIDI basic channel, nnnn = 0 - 15 where nnnn + 1 = channel #
e 0010 0011	Format type (JU-1, JU-2, HS-10, HS-80, MKS-50)
f 1111 0111	End of System Exclusive

5.2 Sequence of communication

5.2.1 In the 'Dump' mode.



5.2.2 In the 'Load' mode.



- Notes :
- * This unit sends RJC and the sequence is discontinued when it receives ERR or detects some error.
 - * This unit sends RJC when the sequence is discontinued manually.
 - * This unit stops the sequence if the unit receives RJC.

MODEL **MKS-50** MIDI Implementation ChartDate: Sep, 05 1986
Version: 1.0

Function.....		Transmitted	Recognized	Remarks
Basic Channel	Default	1-16	1-16	memorized
	Changed	1-16	1-16	
Mode	Default Messages Altered	Mode 3 POLY, OMNI OFF *****	Mode 1, 3 MONO, POLY, OMNI ON/OFF	memorized
Note Number	True voice	X *****	0-127 12-108	
Velocity	Note ON Note OFF	X X	○ v=1-127 X	
After Touch	Key's Ch's	X X	X *	
Pitch Bender		X	* 0-24 semi - tone	9 bit resolution
Control Change	1 5 6 7 64 65 100 101	X X X X X X X X	* Mod. depth * ○ * * Volume * Hold * ○ ○	Modulation Portamento Time Data Entry(MSB) Hold-1 Portamento Switch RPC (LSB) RPC (MSB)
Prog Change	True #	X *****	* 0-127 0-127	
System Exclusive		*	*	
System Common	Song Pos Song Sel Tune	X X X	X X X	
System Real Time	Clock Commands	X X	X X	
Aux Messages	Local ON/OFF All Notes OFF Active Sense Reset	X X X X	X ○ (123-127) ○ X	
Notes		* Can be set to ○ or X and memorized. * * Can adjust the volume of the sound within the level set with the panel volume knob. RPC-PITCH BEND SENSITIVITY only		

Mode 1 : OMNI ON POLY
Mode 3 : OMNI OFF POLYMode 2 : OMNI ON MONO
Mode 4 : OMNI OFF MONO○ : Yes
X : No

6 SPECIFICATIONS

MKS-50: 6 Voice Polyphonic Synthesizer MIDI Sound Module

Memory Capacity: 128 Patches, 128 Tones, 16 Chords

Front Panel

- Headphone Jack (8-15Ω: Stereo)
- Volume Knob
- Display (16 figures, LCD, back-lit)
- Tune/MIDI Button
- Name Button
- Data Transfer Button
- Write Button
- Parameter Button
- Value Button
- Patch Button
- Tone Button
- Number Button
- MIDI Indicator
- Power Switch

Dimension: 480(W) × 290(D) × 44(H) mm
18-7/8" × 11-7/16" × 1-3/4"

Weight: 3.5kg/7 lb 12 oz

Consumption: 16 W

Accessories: MIDI Cable (1m) × 1

OPTIONS

- Stereo Headphones RH-100
- MIDI/SYNC Cable MSC-07, 15, 25, 50, 100
- Programmer PG-300

Rear Panel

- MIDI Connectors (IN, THRU, OUT)
- Load Jack
- Save Jack
- Output Jacks (Mono, Stereo)

MODEL MKS-50 MIDI Implementation Chart

MKS-50

Feature	Implementation	Remarks
1. General MIDI	Yes	
2. 128 Instruments	Yes	
3. 16 Channels	Yes	
4. 10-bit Velocity	Yes	
5. 127 Note Numbers	Yes	
6. 16 Note-offs	Yes	
7. 16 Note-ons	Yes	
8. 16 Aftertouch	Yes	
9. 16 Channel Pressure	Yes	
10. 16 Channel Pitch Bend	Yes	
11. 16 Channel Program Change	Yes	
12. 16 Channel Bank Select	Yes	
13. 16 Channel Sustain	Yes	
14. 16 Channel Reverb	Yes	
15. 16 Channel Chorus	Yes	
16. 16 Channel Tremolo	Yes	
17. 16 Channel Flanger	Yes	
18. 16 Channel Phaser	Yes	
19. 16 Channel Delay	Yes	
20. 16 Channel Distortion	Yes	
21. 16 Channel EQ	Yes	
22. 16 Channel Compressor	Yes	
23. 16 Channel Limiter	Yes	
24. 16 Channel Mixer	Yes	
25. 16 Channel Filter	Yes	
26. 16 Channel Amplifier	Yes	
27. 16 Channel Speaker	Yes	
28. 16 Channel Headphones	Yes	
29. 16 Channel Monitor	Yes	
30. 16 Channel Effects	Yes	
31. 16 Channel Arpeggiator	Yes	
32. 16 Channel Sequencer	Yes	
33. 16 Channel Mixer	Yes	
34. 16 Channel Filter	Yes	
35. 16 Channel Amplifier	Yes	
36. 16 Channel Speaker	Yes	
37. 16 Channel Headphones	Yes	
38. 16 Channel Monitor	Yes	
39. 16 Channel Effects	Yes	
40. 16 Channel Arpeggiator	Yes	
41. 16 Channel Sequencer	Yes	
42. 16 Channel Mixer	Yes	
43. 16 Channel Filter	Yes	
44. 16 Channel Amplifier	Yes	
45. 16 Channel Speaker	Yes	
46. 16 Channel Headphones	Yes	
47. 16 Channel Monitor	Yes	
48. 16 Channel Effects	Yes	
49. 16 Channel Arpeggiator	Yes	
50. 16 Channel Sequencer	Yes	